

gadget^{CO}
TOOLS

BASIC
SKILLCO

topStrong

TopGarden
premium

TopGarden

topchrome

MAKALON

STUTTGART
BAUKRAFT
POWER TOOLS

GREEN
TOOLS



25
euromaster

CATALOGUE
2018



25 ГОДИНИ
EUROMASTER



Евромастер Импорт Експорт ООД от 25 години заема водещо място на пазара на професионални и хоби инструменти в България, постигайки устойчив растеж през годините. С гама от над 6000 артикула, разпределени в няколко собствени продуктови серии, дейността на дружеството е позната и на международните пазари.

Най-важните предпоставки за успех на компанията са:

Опитът, натрупан от изучаване на световните тенденции в търговията с електро и механични инструменти; **Куражът**, да се следва по-трудния, но в перспектива по-успешен път на създаване, развиване и налагане на собствени марки; **Доверието** към всеки служител на фирмата и всеки бизнес партньор.

For 25 years now Euromaster Import-Export Ltd. is a leader in the market of professional and hobby tools in Bulgaria, achieving sustainable growth rate over the years. With a range of over 6000 items, divided in its own brand product lines, the company activities are well known in the international markets.

The most important prerequisites for the company's success are:

Experience gained from the study of global trends in the trade of power and mechanical tools; **The courage** to follow a more difficult, but in long term - more successful way of creating, developing and enforcing its own brands; **The trust** to every employee of the company and business partner.

„Ние знаем в какво сме най-добри и сме насочили цялата си енергия към затвърждаването на позициите ни като лидер на българския пазар. Фокусирани сме върху това да вършим прекрасно работата си, да създаваме инструменти и машини, които да направят живота Ви по-лек и по-добър. Стремим се да бъдем блестящи във всеки детайл, давайки изключителна стойност на нашите продукти. Така постигаме своите успехи.“

“We know what we are good at and direct all our energy to strengthen our position as a leader on the Bulgarian market. We focus on doing our work to a level of perfection, to create tools and machines, to make your life easier and better. We strive to be brilliant in every detail, providing an exclusive value of our products. This is how we achieve our successes.”

СЪДЪРЖАНИЕ / CONTENTS / CONȚINUT

Gadget 4-55

Клеци / Pliers / Clesti.....	5
Отвертки и накрайници / Screwdrivers & bits / Șurubelnițe & biti	8
Накрайници / Bits / Biti.....	14
Шестограми / Hex keys / Imbusi.....	17
Ключове / Spanners / Chei.....	18
Вложки, удължители / Sockets, extensions / Tubulare, adaptoare.....	22
Тресчотки / Ratchets / Manere cu clichet.....	24
Комплекти инструменти / Socket sets / Sets tubulare	25
Измервателни / Measuring / Instrumente de masura.....	29
Чукове / Hammers / Ciocane	32
Режещи / Cutting / Instrumente de taiere	35
Стяги, длета / Clamps, chisels / Prese, dălți.....	42
Пили / Files / Pile	44
Телени четки / Wire brushes / Perii de sârmă.....	46
Менгемета, такери, скоби / Bench vices, staple gun, staples / Menghine, capsator, capse	47
Нитачки / Hand riveters / Pistoale pop-nit	48
Авто / Auto / Auto	49
Лампи, фенери / Lights / Lampi de lucru	53
Органайзери, куфари за инструменти/ Organizers, tool boxes / Organizatoare, truse scule	54
Катинари / Padlocks / Lacăte	55

Basic 56-77

Ключове / Spanners / Chei.....	57
Отвертки, комплекти / Screwdrivers, sets / Șurubelnițe si seturi	58
Комплекти инструменти / Socket sets / Seturi tubulare.....	61
Чукове / Hammers / Ciocane	64
Режещи / Cutting / Instrumente de taiere	65
Измервателни / Measuring / Instrumente de masura.....	71
Длета / Chisels / Dălți.....	73
Нитачки, вакууми / Hand riveters, suction lifters / Clesti pop-nituri, ventuze	74
Телени четки / Wire brushes / Perii de sârmă	75
Авто, вело, други аксесоари / Auto, bicycle, other accessories / Auto, velo si accesorii	76

TopStrong.....78-119

Валяци, комплекти за боядисване / Painting rollers, sets / Trafaleti si seturi	79
Дръжки за валяци / Roller handles / Manere de trafalet.....	83
Четки за боядисване / Painting brushes / Pensule.....	85
Тиксо, покривни найлони, фолио / Masking tapes, Drop sheet, Stretch film / Banda mascare, folie protectie si folie ambalare	89
Пистолети за силикон; за полиуретанова пяна / Caulking guns / Pistoale pentru silicon si spuma	90
Маламашки, мистрии, шпакли / Trowels, scrapers / Glatiere, razuitoare	92
Катинари, заключващи / Padlocks, locks / Lacăte si incuietori.....	98
Железария / Ironware / Feronerie	103
Крепежи / Fasteners / Elemente de fixare.....	107
Предпазни очила, маски, каски / Goggles, dust masks, helmets / Ochelari, masti de praf si casti de protectie	110
Ръкавици / Gloves / Manusi de lucru	111
Дъждобрани, работно облекло / Raincoats, Workwear / Echipament de lucru si pelerine de ploaie.....	115
Работни обувки, гумени ботуши / Working shoes, PVC boots / Incaltaminte de lucru si cizme de cauciuc.....	118

Top Garden 120-149

Поливни / Irrigation / Irigare	121
Пръскачки / Sprayers / Pulverizatoare	131
Градински Уреди / Garden Tools /	133
Градински триони / Garden saws / Ferastraie de gradina	134
Градински ножици / Scissors / Foarfeci	135
Градински инструменти / Garden tools /.....	139
Градински уреди / Appliances /	144
Градински мебели / Garden Furniture / Mobilier de gradina.....	145

Top Garden premium..... 150-163

Поливни / Irrigation / Irigare	151
Градински инструменти / Garden tools / Unelte de gradina.....	156
Градински ножици / Scissors / Foarfeci	160

Makalon164-171

Ключове / Switches / Intreruptoare	165
Контакти / Sockets / Prize.....	167
Разклонители / Extension sockets / Prelungitoare.....	168
Други / Others / Altele	171

TopChrome172-181

Смесители / Faucets / Baterii sanitare.....	173
Душове / Showers / Accesorii dus.....	175
Канелки / Water taps / Robineti	176
Акcesoари за баня / Bathroom accessories / Accesorii de baie.....	176

BauKraft182-186

Електроинструменти / Power tools / Scule electrice.....	183
---	-----

GreenTools.....187-192

Електроинструменти / Power tools / Scule electrice.....	188
---	-----

gadget^{CO}®

TOOLS



Марката **Gadget** на „Евромастер Импорт Експорт“ ООД предлага широка гама ръчни инструменти с добро качество на конкурентни цени. Всеки един продукт от марката **Gadget** е конструиран да послужи за максимално улеснение на работния процес, отговаряйки на съвременните тенденции в DIY пазара. Продуктовата гама на **Gadget** включва широк избор хоби инструментите за домашна употреба и железария, разпределени най-общо в следните продуктови категории:

- Механични инструменти
- Измервателни инструменти
- Водопроводни инструменти
- Автоинструменти и принадлежности
- Подемни инструменти
- Железария

Инструментите **Gadget** се приемат отлично от любители занаятчии, като ги подпомагат в стремежа им да реализират идеите си у дома и ги насърчават да разчитат на собствените си умения и креативни идеи. Всичко това превръща инструментите Gadget в необходимо и желано допълнение за всяка една домашна работилница.

The brand **Gadget** owned by Euro-master Import Export LTD offers a wide range of hand tools with good quality at competitive prices. Each product under the brand Gadget is designed to assure facilitation of the workflow and in the meantime to meet the modern trends in DIY market. The product mix includes a wide range of hobby tools for home use and hardware, divided broadly into the following categories:

- Mechanical tools
- Measuring tools
- Plumbing tools
- Auto tools and accessories
- Lifting tools
- Ironmongery

The **Gadget** tools are excellently accepted by craftsmen, supporting them in realizing their ideas at home and encouraging them to rely on their own skills and creative ideas. This makes the Gadget tools a desired part /add-on in any home-workshop.

Brandul **Gadget**, ce apartine de Euro-master Import Export, ofera o larga varietate de unelte de mana de buna calitate la preturi competitive. Fiecare produs din gama Gadget este creat pentru a usura munca, in timp ce face fata standardelor moderne ale pietei DIY (Do It Yourself) Acest mix de produse include a gama larga de unelte hobby pentru uz casnic, clasificandu-se in mare parte in aceste categorii:

- Unelte mecanice
- Unelte de masurat
- Unelte pentru instalatii
- Unelte si accesorii auto
- Unelte de ridicat
- Feronerie

Uneltele **Gadget**, sunt foarte bine vazute de catre meseriasii, incurajandu-i pe acestia sa se bazeze pe aptitudinile, abilitatile si ideile lor creative. Aceasta calitate, fac ca gama Gadget sa fie dorita in orice atelier de casa.



Клеци комбинирани с гвукмп. гръжка / Combination pliers, bi-material handles / Cleste combinat maner bi-material

art.№	size	box	ctn
210521	160 mm	12	60
210522	180 mm	12	60
210523	200 mm	12	60

- Двукмпонентна ергономична дръжка
- Индукционно закалени режещи ръбове
- Закалена глава за по-голяма здравина по време на работа
- Гравирано лого на дръжката.
- Ergonomic bi-material handles
- Induction hardened cutting edges
- Precision-hardened pliers head for on-the-job toughness.
- Carved logo on the handles
- Măner ergonomic bi-material
- Partile taietoare tratate prin inductie
- Falci calite pentru duritate crescuta
- Marcaj cu logo pe manere



Клеци резачки с гвукмп. гръжка / Diagonal cutting pliers, bi-material handles / Cleste sfic maner bi-material

art.№	size	box	ctn
210526	160 mm	12	60
210527	200 mm	12	60

- Двукмпонентна ергономична дръжка
- Индукционно закалени режещи ръбове
- Закалена глава за по-голяма здравина по време на работа
- Гравирано лого на дръжката.
- Ergonomic bi-material handles
- Induction hardened cutting edges
- Precision-hardened pliers head for on-the-job toughness.
- Carved logo on the handles
- Măner ergonomic bi-material
- Partile taietoare tratate prin inductie
- Falci calite pentru duritate crescuta
- Marcaj cu logo pe manere



Клеци дългоустни с гвукмп. гръжка / Long nose pliers, bi-material handles / Cleste varf lung maner bi-material

art.№	size	box	ctn
210524	160 mm	12	60
210525	200 mm	12	60

- Двукмпонентна ергономична дръжка
- Индукционно закалени режещи ръбове
- Закалена глава за по-голяма здравина по време на работа
- Гравирано лого на дръжката.
- Ergonomic bi-material handles
- Induction hardened cutting edges
- Precision-hardened pliers head for on-the-job toughness.
- Carved logo on the handles
- Măner ergonomic bi-material
- Partile taietoare tratate prin inductie
- Falci calite pentru duritate crescuta
- Marcaj cu logo pe manere



Клеци за почистване на кабел до 3.5 mm / Wire stripper satin plated up to 3.5mm / Cleste pentru decablat

art.№	size	box	ctn
212711	160 mm	12	60

- Двукмпонентна ергономична дръжка
- Индукционно закалени режещи ръбове
- Закалена глава за по-голяма здравина по време на работа
- Гравирано лого на дръжката.
- Ergonomic bi-material handles
- Induction hardened cutting edges
- Precision-hardened pliers head for on-the-job toughness.
- Carved logo on the handles
- Măner ergonomic bi-material
- Partile taietoare tratate prin inductie
- Falci calite pentru duritate crescuta
- Marcaj cu logo pe manere



gadget[®]
TOOLS

Basic
STAINLESS

topStrong

TopGarden

TopGarden
premium

MAKALON

topchrome

BAUKRAFT
POWER TOOLS

GREEN
TOOLS



Клеци с г/вукомп. гръжка, к-м 3 бр. / Pliers bi-material handles, 3pcs set / Set 3 clesti maner bi-material



art.№	size	box	ctn
213125	160 mm	6	24

- Двуконпонентна ергономична дръжка
- Индукционно закалени режещи ръбове
- Закалена глава за по-голяма здравина по време на работа.
- Ergonomic bi-material handles
- Induction hardened cutting edges
- Precision-hardened pliers head for on-the-job toughness.
- Măner ergonomic bi-material
- Partile taietoare tratate prin inductie
- Falci calite pentru duritate crescuta

Клеци мини комбинирани / Mini combination pliers / Mini cleste combinat



art.№	size	box	ctn
212011	110 mm	12	120

- Двуконпонентна ергономична дръжка
- Индукционно закалени режещи ръбове
- Закалена глава за по-голяма здравина по време на работа.
- Ergonomic bi-material handles
- Induction hardened cutting edges
- Precision-hardened pliers head for on-the-job toughness.
- Măner ergonomic bi-material
- Partile taietoare tratate prin inductie
- Falci calite pentru duritate crescuta

Клеци мини резачки / Mini diagonal cutting pliers / Mini cleste sfic



art.№	size	box	ctn
212012	100 mm	12	120

- Двуконпонентна ергономична дръжка
- Индукционно закалени режещи ръбове
- Закалена глава за по-голяма здравина по време на работа.
- Ergonomic bi-material handles
- Induction hardened cutting edges
- Precision-hardened pliers head for on-the-job toughness.
- Măner ergonomic bi-material
- Partile taietoare tratate prin inductie
- Falci calite pentru duritate crescuta

Клеци мини дългоустни / Mini long nose pliers / Mini cleste varf lung



art.№	size	box	ctn
212010	110 mm	12	120

- Двуконпонентна ергономична дръжка
- Индукционно закалени режещи ръбове
- Закалена глава за по-голяма здравина по време на работа.
- Ergonomic bi-material handles
- Induction hardened cutting edges
- Precision-hardened pliers head for on-the-job toughness.
- Măner ergonomic bi-material
- Partile taietoare tratate prin inductie
- Falci calite pentru duritate crescuta

Клеци мини секачки г/вукомп. гръжка / Mini end cutting pliers / Mini cleste tais frontal



art.№	size	box	ctn
212013	100 mm	12	120

- Двуконпонентна ергономична дръжка
- Индукционно закалени режещи ръбове
- Закалена глава за по-голяма здравина по време на работа.
- Ergonomic bi-material handles
- Induction hardened cutting edges
- Precision-hardened pliers head for on-the-job toughness.
- Măner ergonomic bi-material
- Partile taietoare tratate prin inductie
- Falci calite pentru duritate crescuta



Клеци комбинирани, пластм. гръжка / Combination pliers, plastic handles / Cleste combinat, maner plastic

art.№	size	box	ctn
210501	160 mm	12	60
210502	180 mm	12	60

- Пластмасова дръжка
- Индукционно закалени режещи ръбове
- Закалена глава за по-голяма здравина по време на работа
- Plastic handles
- Induction hardened cutting edges
- Precision-hardened pliers head for on-the-job toughness
- Mâner plastic
- Partile taietoare tratate prin inductie
- Falci calite pentru duritate crescuta



Клеци резачки, пластм. гръжка / Diagonal cutting pliers, plastic handles / Cleste sfic maner, plastic

art.№	size	box	ctn
211201	160 mm	12	60

- Пластмасова дръжка
- Индукционно закалени режещи ръбове
- Закалена глава за по-голяма здравина по време на работа
- Plastic handles
- Induction hardened cutting edges
- Precision-hardened pliers head for on-the-job toughness
- Mâner plastic
- Partile taietoare tratate prin inductie
- Falci calite pentru duritate crescuta



Клеци гългоустни, пластм. гръжка / Long nose pliers, plastic handles / Cleste varf lung, maner plastic

art.№	size	box	ctn
210701	160 mm	12	60

- Пластмасова дръжка
- Индукционно закалени режещи ръбове
- Закалена глава за по-голяма здравина по време на работа
- Plastic handles
- Induction hardened cutting edges
- Precision-hardened pliers head for on-the-job toughness
- Mâner plastic
- Partile taietoare tratate prin inductie
- Falci calite pentru duritate crescuta



Клеци мун "гарга" / Water pump pliers / Cleste papagal

art.№	size	box	ctn
210546	250 mm	12	60

- Двуконтактна ергономична дръжка
- Закалени челюсти
- Ergonomic bi-material handle
- Hardened jaws
- Mâner ergonomic bi-material
- Falci calite



Клеци чупак / Locking pliers self grip curved jaw / Cleste autoblocant falci curbate

art.№	size	box	ctn
213120	125 mm	-	100
213121	175 mm	20	60
213122	250 mm	6	60

- Двуконтактна ергономична дръжка; Закалени челюсти
- Регулиращ болт за силата на захвата; Триточково запояване
- Лост за бързо освобождаване
- Ergonomic bi-material handle; Hardened jaws; Adjustable screw for pressing force; 3-pointed soldering for greater strength during work; Quick release lever
- Mâner ergonomic bi-material; Falci calite
- Eliberare rapidă; Forta de strangere reglabila





Клеци чирак с угълж. плоски челюсти / Locking pliers self grip straight jaw / Cleste autoblocant falci drepte



art.№	size	box	ctn
213124	210 mm	20	60

- Двуконпонентна ергономична дръжка
- Закалени челюсти; Регулиращ болт за силата на захвата
- Триточково запояване за по-голяма здравина при работа
- Лост за бързо освобождаване

- Ergonomic bi-material handle; Hardened jaws
- Adjustable screw for pressing force
- 3-pointed soldering for greater strength during work
- Quick release lever

- Măner ergonomic bi-material
- Falci calite; Eliberare rapidă
- Forta de strangere reglabila

Клеци керпеген / Carpenter Pincer / Cleste cuie



art.№	size	box	ctn
210528	175 mm	12	60
210529	200 mm	12	60

- Индукционно закалени режещи ръбове
- Закалена глава за по-голяма здравина по време на работа
- Гумирани дръжки

- Induction hardened cutting edges
- Precision-hardened pliers head for on-the-job toughness
- Rubber-covered handles

- Partile taietoare tratate prin inductie
- Falci calite pentru duritate crescuta
- Mănere cauciucate

Клеци арматурни / Tower Pincer / Cleste cuie lung



art.№	size	box	ctn
210530	225 mm	12	60
210531	250 mm	12	60

- Индукционно закалени режещи ръбове
- Закалена глава за по-голяма здравина по време на работа
- Гумирани дръжки

- Induction hardened cutting edges
- Precision-hardened pliers head for on-the-job toughness
- Rubber-covered handles

- Partile taietoare tratate prin inductie
- Falci calite pentru duritate crescuta
- Mănere cauciucate

Отвертка права, г/вуконп. гръжка / Screwdriver slotted, TPR handle / Surubelnita dreapta, maner TPR



- Материал: CR-V
- Намагнетизиран връх
- Двуконпонентна ергономична дръжка
- Material: CR-V
- Magnetic tip
- Ergonomic bi-material handle
- Material: CR-V
- Vârf magnetizat
- Măner ergonomic



art. №	size	box	ctn
221201	3x100 mm	12	240
221202	4x100 mm	12	240
221203	4x150 mm	12	240
221204	5x75 mm	12	240
221205	5x100 mm	12	240
221206	6x100 mm	12	240
221207	6x125 mm	12	240
221208	6x150 mm	12	240
221209	8x200 mm	12	240

Отвертка кръстата, г/вуконп. гръжка / Screwdriver Phillips, TPR handle / Surubelnita Phillips, maner TPR



- Материал: CR-V
- Намагнетизиран връх
- Двуконпонентна ергономична дръжка
- Material: CR-V
- Magnetic tip
- Ergonomic bi-material handle
- Material: CR-V
- Vârf magnetizat
- Măner ergonomic



art. №	size	box	ctn
221025	PH0 3x100 mm	12	240
221026	PH1 4x100 mm	12	240
221027	PH1 5x75 mm	12	240
221028	PH1 5x100 mm	12	240
221029	PH1 5x125 mm	12	240
221030	PH2 6x100 mm	12	240
221031	PH2 6x125 mm	12	240
221032	PH2 6x150 mm	12	240



Отвертки с гъвкав. гръжка, к-м 6бр. / Screwdrivers, TPR handle, 6pcs set / Set 6 Surubelnite, maner TPR

art. №	pieces	box	ctn
221301	6		48

- Размери: SL3x100mm; SL4x100mm; SL5x100mm; PH1 4x100mm; PH1 5x100mm; PH2 6x125mm;
- Материал: CR-V; Намагнетизиран връх
- Двуконпонентна ергономична дръжка
- Sizes: SL3x100mm; SL4x100mm; SL5x100mm; PH1 4x100mm; PH1 5x100mm; PH2 6x125mm;
- Material: CR-V; Magnetic tip
- Ergonomic bi-material handle
- Marimi: SL3x100mm; SL4x100mm; SL5x100mm; PH1 4x100mm; PH1 5x100mm; PH2 6x125mm;
- Material: CR-V; Vârf magnetizat; Mâner ergonomic



Отвертка права, пластм. гръжка / Screwdriver slotted, plastic handle / Surubelnita cu maner plastic-dreapta

art.№	size	box	ctn
222005	4x75 mm	12	300
222006	6x100 mm	12	240
222007	6x125 mm	12	240
222008	6x150 mm	12	240

- Материал: CR-V
- Ергономична пластмасова дръжка
- Material: CR-V
- Ergonomic plastic handle
- Material: CR-V
- Mâner ergonomic din plastic



Отвертка кръстата, пластм. гръжка / Screwdriver phillips, plastic handle / Surubelnita cu maner plastic

art.№	size	box	ctn
222001	4x75 mm	12	300
222002	6x100 mm	12	240
222003	6x125 mm	12	240
222004	6x150 mm	12	240

- Материал: CR-V
- Ергономична пластмасова дръжка
- Material: CR-V
- Ergonomic plastic handle
- Material: CR-V
- Mâner ergonomic din plastic



Отвертка торкс / Screwdriver torx / Surubelnita torx

art.№	size	box	ctn
223001*	T15	12	240
223003*	T25	12	240
223004*	T30	12	240

- *Трайно намалена цена / Sale price / Pret de vanzare
- Материал: CR-V
 - Ергономична пластмасова дръжка
 - Material: CR-V
 - Ergonomic plastic handle
 - Material: CR-V
 - Mâner ergonomic din plastic



Отвертки торкс, к-м 4 бр. / Screwdrivers torx, 4 pcs set / Set 4 surubelnite torx

art.№	size	box	ctn
225402	T5, T6, T7, T8	50	400

- Материал: CR-V
- Ергономична пластмасова дръжка
- Material: CR-V
- Ergonomic plastic handle
- Material: CR-V
- Mâner ergonomic din plastic





Отвертка за накрайници, гъвкава 250 mm / Screwdriver for bits, flexible 250 mm / Maner ptr biti, flexibil 250 mm



art.No	size	box	ctn
221401	1/4"	10	100

- Гъвкаво рамо, позволяващо работа на труднодостъпни места
- Материал на рамото: CR-V
- Полирано рамо, устойчиво на корозия
- Намагнетизиран край
- Двуконпонентна, релефна дръжка, за по-добър захват
- Flexible shank for work at hardly accessible places
- Shank material: Cr-V
- Polished shank, corrosion resistant
- Magnetic tip
- Bi-material embossed handle for better grip.
- Tija flexibila pentru lucrul în locuri greu accesibile
- Material: CR-V, rezistent la coroziune
- Mâner ergonomic bi-material

Отвертка тресчотка с 6 бр двойни накрайници / Ratchet screwdriver with 6 pcs double bits / Surubelnita cu clichet cu 6 biti 2 capete



art.No	size	box	ctn
330559	1/4"	-	48

Съдържание / Contents / Continut:

- 1 x 1/4" Тресчотка/Ratchet handle/Surubelnita cu clichet 110 mm
- 6 x Накрайници двойни/Bits double ended/Biti dubla: SL4mm/PH1; SL5mm/PH2; SL6mm/PH3; H4mm/PZ1; H5mm/PZ6mm; H6mm/PZ3;

Отвертка ударна с 6 накрайника в кутия / Hand Impact Screwdriver with 6 bits / Surubelnita impact cu 6 biti

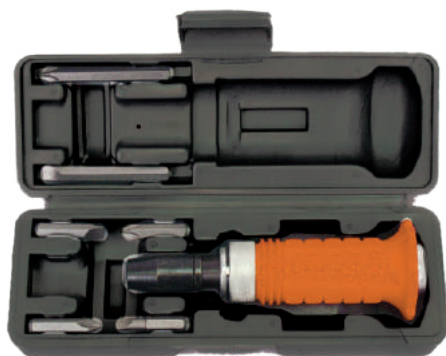

art.No	size	box	ctn
224907	-	-	25

• Накрайници / Bits / Biti:

- x2 35 mm - 6, 8 mm
- x1 70mm - 8 mm
- x2 35 mm - PH2, PH3
- x1 70 mm - PH3

Отвертка тресчотка с накрайници, к-м 13 части / Ratchet screwdriver with bits, 13 pcs set / Set maner surubelnita cu clichet, 13 pcs

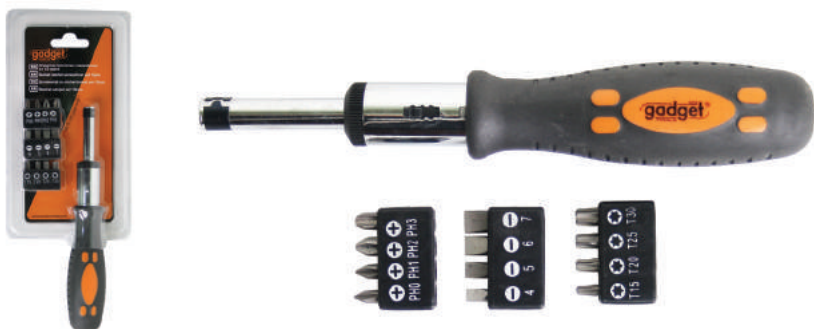

art.No	size	box	ctn
225201	1/4"	6	36

• 1 1/4" Тресчотка / Ratchet handle / Surubelnita cu clichet 180mm

• Накрайници / Bits / Biti:

- x4 SL4, SL5, SL6, SL7 mm
- x4 PH0, PH1, PH2, PH3
- x4 T15, T20, T25, T30



Отвертка-тресчотка, чупеца, с накрайници, к-м 14 часту / 3-way ratchet screwdriver with bits, 14pcs set / Set maner surubelnita cu clichet, 14 pcs

art.№	size	box	ctn
225203	1/4"	6	36

- 1 x 1/4" Тресчотка 5-позиционна/5-way Ratchet handle/Surubelnita cu clichet 5 moduri
- 1 x 1/4" Удължител за накрайници/ Extension bar/Adaptoare lung 60 mm
- 12 бр./25mm Накрайници / Bits / Biti:
 - x4 SL4, SL5, SL6, SL7 mm
 - x4 PH0, PH1, PH2, PH3
 - x4 T15, T20, T25, T30



Отвертка-тресчотка Т с накрайници, к-м 16 часту / Ratchet screwdriver T handle with bits, 16 pcs set / Surubelnita cu clichet, maner "T" 16 pcs

art.№	size	box	ctn
225204	1/4"	6	36

- 1 x 1/4" Т-образна тресчотка/T- type Ratchet handle/Surubelnita cu clichet de tip "T"
- 16 бр. Накрайници / Bits / Biti:
 - x3 SL4, SL5, SL6 mm
 - x5 PH0, PH1, PH2, PH3 (x2)
 - x4 PZ0, PZ1, PZ2, PZ3
 - x3 T10, T15, T20



Отвертка с накрайници и вложки, к-м 16 ч. пластм. кутия / Screwdriver w. bits/sockets, 16 pcs set / Set surubelnita cu biti si tubulare, 16 pcs

art.№	size	box	ctn
225205	1/4"	10	40

- 1 x 1/4" Отвертка за накрайници / Screwdriver / Surubelnita ptr biti 200mm
- 1 x 1/4" Адаптор за вложки/ADP for sockets/Adaptor ptr tubulare
- 6 x 1/4" Вложки/Sockets/Tubulare: 5, 6, 7, 8, 9, 10 mm
- 8 бр. Накрайници / Bits / Biti:
 - x3 SL4, SL5, SL6 mm
 - x3 PH1, PH2, PH3
 - x2 T15, T20





Отвертка-тресчотка с цветни накрайници, к-м 26 часту / Ratchet screwdr. w. colored bits, 26pcs set / Set surubelnita cu clichet, 26 pcs



art.No	size	box	ctn
225208	1/4"	6	24

- 1 x 1/4" Тресчотка / Ratchet handle / Surubelnita cu clichet 100mm
- 1 x Гъвкав удължител / Flexible extension / Adaptoare lung flexibil 180mm
- Накрайници цветни/Colorful Bits/Biti culoare (25mm):
 - x4 SL3, SL4, SL5, SL6 (черни/black / negru)
 - x4 PH0, PH1, PH2, PH3 (сини/blue / albastru)
 - x4 T10, T15, T20, T25 (оранжеви / orange)
 - x4 PZ0, PZ1, PZ2, PZ3 (жълти/yellow/galben)
 - x4 H3, H4, H5, H6 (зелени / green / verde)
 - x4 S0, S1, S2, S3 (червени / red / rosu)

Отвертка с накрайници-прецизни, к-м 32 часту / Screwdriver with precision bits, 32 pcs set / Set surubelnita cu biti precizie, 32 pcs



art.No	size	box	ctn
229918	-	6	48

- 1 x Отвертка за накрайници / Screwdriver / Surubelnita 125 mm
- 316р.Накрайници прецизни/Precision bits/ Biti precizie:
 - x5 SL1, SL2, SL3, SL4, SL5 mm
 - x5 PH000, PH00, PH0, PH1, PH2
 - x5 PZ000, PZ00, PZ0, PZ1, PZ2
 - x5 T10, T15(x2), T20(x2)
 - x6 H2(x2), H3(x2), H4(x2)
 - x5 S0, S1(x2), S2(x2)

Отвертка - тресчотка с накрайници к-м 38 часту / Ratchet screwdriver with bits, 38 pcs set / Set surubelnita cu clichet, 38 pcs



art.No	size	box	ctn
229917	1/4"	6	48

- 1 x 1/4" Тресчотка/Ratchet handle/ Surubelnita cu clichet 115mm
- 376р./25mm Накрайници / Bits / Biti:
 - x6 SL2, SL3, SL4, SL5, SL6, SL7 mm
 - x9 PH00(x2), PH0(x2), PH1(x2), PH2, PH3(x2)
 - x7 T8, T10, T15, T20, T25, T27, T30
 - x6 H2, H3, H4, H5, H6, H7 mm
 - x8 S0(x2), S1(x2), S2(x2), S3(x2)



Отвертка-тресчотка с накрайници и вложки, к-м 49 часту / Ratchet screwdriver with bits/sockets, 49 pcs set / Set surubelnita cu clichet si tubulare, 49 pcs

art.№	size	box	ctn
225209	1/4"	8	24

- 1 x 1/4" Тресчотка / Ratchet handle / Surubelnita cu clichet 145 mm
- 1 x 1/4" Адаптор за вложки/ADP for sockets/Adaptor ptr tubulare
- 1 x 1/4" Удължител / Extension bar / Adaptoare lung 70 mm
- Накрайници цветни/Colorful Bits/Biti culoare (25 mm):
- 9 x 1/4" Вложки/Sockets/Tubulare: 5, 6, 7, 8, 9, 10, 11, 12, 13 mm
- x6 SL3, SL4, SL5, SL5.5, SL6, SL7 mm
- x6 PH0, PH1, PH2(x3), PH3
- x8 T8, T10, T15, T20, T25, T27, T30, T40
- x6 PZ0, PZ1, PZ2(x3), PZ3
- x7 H2, H2.5, H3, H4, H5, H5.5, H6 mm
- x4 S0, S1, S2, S3



Отвертка-тресчотка Т гръжка "2 в 1" с накр., к-м 61 часту / Ratchet screwdr. T handle "2 in 1" w. bits, 61 pcs set / Surubelnita cu clichet, maner "T", 61 pcs

art.№	size	box	ctn
225206		10	40

1 x Т-образна тресчотка "2 в 1"/T- type Ratchet handle "2 in 1"/ Surubelnita cu clichet de tip "T" 2 in 1

Накрайници прецизни/Precision bits/Biti precizie:

- x7 SL1, SL1.5, SL2, SL2.5, SL3, SL3.5, SL4mm
- x4 PH000, PH00, PH0, PH1
- x8 H0.7, H0.9, H1.3, H1.5, H2, H2.5, H3, H4mm
- x9 T4, T5, T6, T7, T8, T9, T10, T15, T20
- x1 2.3mm
- x2 PZ0, PZ1
- x2 TRI-WING: 2, 3mm
- x1 SPANNER: 2.6mm
- x2 STAR: 1.5, 2mm

Накрайници/Bits/Biti 1/4" x 25 mm:

- x5 SL3, SL4, SL5, SL6, SL7
- x4 PH0, PH1, PH2, PH3
- x4 H3, H4, H5, H6
- x7 T10, T15, T20, T25, T27, T30, T40
- x4 PZ0, PZ1, PZ2, PZ3



Комплект инструменти 31 часту / 31pcs/set socket wrench / Set 31 buc

art.№	size	box	ctn
330560	1/4"	-	20

- 1 x 1/4" Тресчотка / Ratchet handle / Surubelnita cu clichet 130mm
- 2 x Отвертки прецизни/Precision screwdrivers/Surubelnite precizie: SL; PH;
- 8 x 1/4" Вложки/Sockets/Tubulare: 5.5, 6, 7, 8, 10, 11, 12, 13mm
- 1 x 1/4" Адаптор за вложки/ADP for sockets/Adaptor ptr tubulare
- 18 бр. Накрайници / Bits / Biti:
- x3 SL4, SL5.5, SL7 mm
- x4 PH1, PH2 (x2), PH3
- x6 T8, T10, T15, T20, T25, T30
- x5 H2, H2.5, H3, H4, H5 mm





Накрайници за отвертка, к-м 10 бр. / 10 pcs set Screwdriver bits / Set biti 10 buc



art.№	size	box	ctn
390710	PH1 x 25 mm	10	200
390711	PH2 x 25 mm	20	200
390712	PH3 x 25 mm	-	200

- Материал: S2
- Material: S2
- Material: S2

Накрайници за отвертка, к-м 10 бр. / 10 pcs set Screwdriver bits / Set biti 10 buc

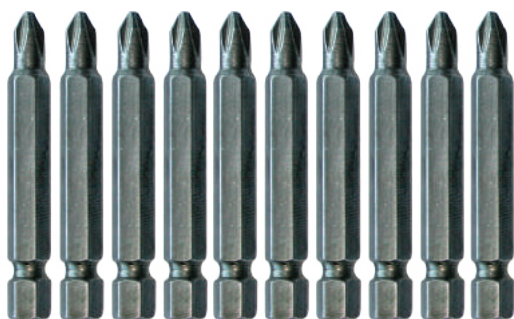

art.№	size	box	ctn
390713	PH1 x 50 mm	-	200
390714	PH2 x 50 mm	-	200
390715	PH3 x 50 mm	-	200

- Материал: S2
- Material: S2

Накрайници двойни, к-м 10 бр. / 10 pcs set Double ended bits / Set 10 biti 2 capete



art.№	size	box	ctn
390507	-	10	100

- Накрайници двойни/Bits double ended/Biti dubla 65mm:
- x4 SL3, SL4, SL5, SL6 mm
- x3 PH1, PH2, PH3
- x3 PZ1, PZ2, PZ3

Накрайници, к-м 12 бр. / Double ended bit set 12 pcs / Set 12 biti 2 capete

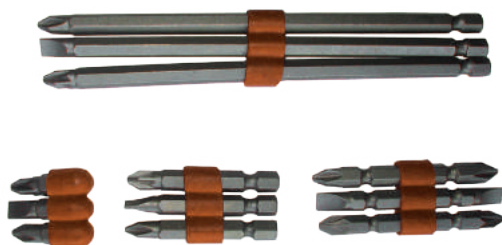

art.№	size	box	ctn
390508	-	20	100

- Накрайници / Bits / Biti:
- 3 x 25mm: SL6mm, PH2, PZ2
- 3 x 50mm: SL6mm, PH2, PZ2
- 3 x 150mm: SL6mm, PH2, PZ2
- 3 x 65mm Накрайници двойни/ Bits double ended/Biti dubla: SL6mm, PH2, PZ2



Накрайници и Вложки, к-м 12 бр. / Bits, sockets, 12 pcs set / Set 12 biti si tubulare

art.No	size	box	ctn
390704	1/4"	24	96



• Вложки / Sockets / Tubulare: 5, 6, 7, 8mm



• 1 x 1/4" Адаптор за вложки / ADP for sockets / Adaptor ptr tubulare



• PH1 x 50mm



• T20 x 50mm



• PH2 x 50mm



• H3 x 50mm



• SL4 x 50mm



• H4 x 50mm



• SL7 x 50mm



Накрайници, к-м 33 бр. / Bits set 33pcs / Set 33 biti

art.No	size	box	ctn
390706	1/4"x25mm	24	96



• 1/4" X 60mm Магнитен удължител /
• Magnetic bit holder /Magnetic bit suport



• Накрайници / Bits / Biti 1/4"x25mm:



• x4 SL3, SL4; SL5, SL6mm



• x7 PH0, PH1, PH2(x4), PH3



• x7 PZO, PZ1, PZ2(x4), PZ3



• x6 T6, T7, T10, T15, T20, T25



• x4 H3, H4, H5, H6mm



• x4 S0, S1, S2, S3

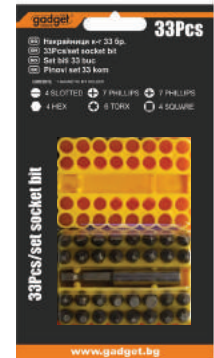

Накрайници 3/8" и 1/2", к-м 40 бр. / Bits 3/8" & 1/2", 40pcs set / Set 40 biti + adaptor 3/8" si 1/2"

art.No	size	box	ctn
390702	1/2", 3/8"	-	10



• x2 Вложки / Socket / Tubulare 1/2", 3/8"



• Накрайници / Bits / Biti:



• x14 30mm: T20, T25, T30, T40, T45, T50, T55
75mm: T20, T25, T30, T40, T45, T50, T55



• x10 30mm: M5, M6, M8, M10, M12
75mm: M5, M6, M8, M10, M12



• x14 30mm: H4, H5, H6, H7, H8, H10, H12mm
75mm: H4, H5, H6, H7, H8, H10, H12mm



Накрайници, к-м 100 бр/ Bits set 100pcs / Set 100 biti

art.No	size	box	ctn
390707	-	-	20



6 FRACTIONAL HEX TAMPER PROOF



9 TORX



3 SPLINE



8 PHILLIPS



9 TORX



4 SQUARE RECESS



8 POZIDRIVE



4 TRIWING



3 CLUTCH



10 FRACTIONAL HEX



6 METRIC HEX TAMPER PROOF



9 METRIC HEX

1 1/4"SQ. x 1/4"HEX x 1"EXTENSION



3 TORQ SET

1 1/4"SQ. x 1/4"HEX x 2"EXTENSION



4 SPANNER

1 MAGNETIC BIT HOLDER



9 SLOTTED

1 SOCKET BIT HOLDER

1 WING NUT DRIVER





Накрайници за монтаж на гипсокартон, к-м 10 бр. / 10 pcs/set Drywall screw bit / Set 10 biti pt gips carton



art.No	size	box	ctn
390709	-	10	100

- Материал: S2
- Material: S2

Накрайник за самопробивни винтове / Nut setter socket / Bit tubulara cu cap magnetic



art.No	size	box	ctn
330581	8x42 mm	20	200
330582	8x65 mm	20	200
330583	10x42 mm	20	200
330584	10x65 mm	20	200
338001	13x42 mm	20	200
338002	13x65 mm	20	200

Накрайници за самопробивни винтове, к-м 5 бр. / 5pcs/set Nut setter sockets / Set 5 biti tubulare cu cap magnetic



art.No	size	box	ctn
330585	8x42 mm	10	100
330586	8x65 mm	10	100
330587	10x42 mm	10	100
330588	10x65 mm	10	100

Магнитен удължител за накрайници, к-м 5бр./ 5 pcs/set Magnetic bit holder / Set 5 adaptoare magnetice pt biti



art.No	size	box	ctn
390708	-	10	200

- Материал: S2
- Material: S2

Шестограми 9 бр., 1.5-10 mm / Hex key 9 pcs 1.5-10 mm / Set 9 chei imbus 1.5-10 mm

art.№	box	ctn
390150	6	60
390153	6	60
390156	6	60

Ø mm	390150*		390153**		390156***	
	L (mm)	L ₁ (mm)	L (mm)	L ₁ (mm)	L (mm)	L ₁ (mm)
1.5	45	15	75	15	90	13
2	50	15	80	15	100	15
2.5	55	20	85	15	115	18
3	50	20	95	18	125	20
4	70	20	105	20	140	23
5	80	25	115	23	155	25
6	90	28	125	25	170	28
8	100	30	155	28	190	32
10	115	35	160	30	215	35

* Скъсени - Short arm - Scurte

** Средни - Long arm - Medii

*** Удължени - Extra long arm - Lungi

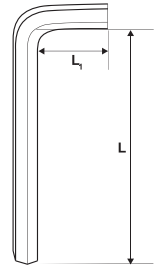

Шестограми Torx с отвор, k-m 9 броя T10-T50/ Torx key temper resistant, 9 pcs / Set 9 chei torx L

art.№	box	ctn
390151	6	60
390154	6	60
390157	6	60

T	390151*		390154**		390157***	
	L (mm)	L ₁ (mm)	L (mm)	L ₁ (mm)	L (mm)	L ₁ (mm)
T10	50	16	75	16	80	16
T15	56	18	80	18	98	18
T20	60	20	90	20	112	20
T25	68	22	95	22	126	22
T30	84	29	124	29	158	29
T35						
T40	95	33	137	33	184	33
T45	105	37	156	37	205	37
T50	116	42	180	42	228	42

* Скъсени - Short arm - Scurte

** Средни - Long arm - Medii

*** Удължени - Extra long arm - Lungi

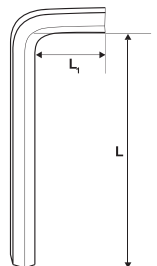

Шестограми за работа под ъгъл, k-m 9 бр. / Hex key ball ended, 9 pcs 1.5-10 mm / Set 9 chei imbus cu bila

art.№	box	ctn
390152	6	60
390155	10	60
390158	6	60

Ø mm	390152*		390155**		390158***	
	L (mm)	L ₁ (mm)	L (mm)	L ₁ (mm)	L (mm)	L ₁ (mm)
1.5	45	15	75	15	90	13
2	50	15	80	15	100	15
2.5	55	20	85	15	115	18
3	50	20	95	18	125	20
4	70	20	105	20	140	23
5	80	25	115	23	155	25
6	90	28	125	25	170	28
8	100	30	155	28	190	32
10	115	35	160	30	215	35

* Скъсени - Short arm - Scurte

** Средни - Long arm - Medii

*** Удължени - Extra long arm - Lungi

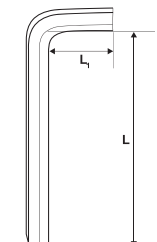



Ключ гаечен / D.O.E. spanner / Cheie fixa



NEW

- Полирана глава
- Матово покритие на тялото
- Лазерно принтирано лого
- Polished head
- Matted body
- Laser printed logo
- Maner satinat
- Logo imprimat cu laser

DIN 3110



art. №	size	box	ctn
230322	6x7 mm	20x5 бр.	400
230323	8x9 mm	15x5 бр.	300
230324	10x11 mm	10x5 бр.	200
230325	12x13 mm	10x5 бр.	200
230326	14x15 mm	5x5 бр.	100
230327	16x17 mm	5x5 бр.	100
230328	18x19 mm	5x5 бр.	100
230329	20x22 mm	4x5 бр.	80
230330	21x23 mm	4x5 бр.	80
230331	24x27 mm	3x5 бр.	60
230332	30x32 mm	2x5 бр.	40

Ключ звездогаечен / Combination spanner / Cheie combinata



NEW

- Полирана глава
- Матово покритие на тялото
- Лазерно принтирано лого
- Polished head
- Matted body
- Laser printed logo
- Maner satinat
- Logo imprimat cu laser

DIN 3110



art. №	size	box	ctn
230723	6mm	15x5 бр.	300
230724	7 mm	25x5 бр.	500
230725	8 mm	20x5 бр.	400
230726	9 mm	20x5 бр.	400
230727	10 mm	10x5 бр.	200
230728	11 mm	10x5 бр.	200
230729	12 mm	10x5 бр.	200
230730	13 mm	10x5 бр.	200
230731	14 mm	8x5 бр.	160
230732	15 mm	7x5 бр.	140
230733	16 mm	7x5 бр.	140
230734	17 mm	5x5 бр.	100
230735	18 mm	5x5 бр.	100
230736	19 mm	5x5 бр.	100
230737	21 mm	5x5 бр.	100
230738	22 mm	4x5 бр.	80
230739	24 mm	3x5 бр.	60
230740	27 mm	2x5 бр.	40
230741	30 mm	2x5 бр.	40
230742	32 mm	2x5 бр.	40

Ключ гаечен, к-т 8 бр. на стойка / D.O.E. spanners, 8pcs set / Cheie fixa, 8 pcs set



NEW

art. №	size	box	ctn
230401	6-22 mm	5	20

- Полирана глава
- Матово покритие на тялото
- Лазерно принтирано лого
- Функционална пластмасова стойка
- Polished head
- Matted body
- Laser printed logo
- Functional plastic stand
- Maner satinat
- Logo imprimat cu laser
- Suport functional din plastic

8 pcs

DIN 3110



Ключ гаечен, к-м 12бр. на стойка / D.O.E. spanners, 12pcs set / Cheie fixa, 12pcs set

art. №	size	box	ctn
230402	6-32 mm	2	8

- Полирана глава
- Матово покритие на тялото
- Лазерно принтирано лого
- Функционална пластмасова стойка
- Polished head
- Matted body
- Laser printed logo
- Functional plastic stand
- Maner satinat
- Logo imprimat cu laser
- Suport functional din plastic



Ключ звездогаечен, к-м 8 бр. на стойка / Combination spanners, 8 pcs set / Set 8 chei combinate

art. №	size	box	ctn
233301	8-19 mm	8	32

- Полирана глава
- Матово покритие на тялото
- Лазерно принтирано лого
- Функционална пластмасова стойка
- Polished head
- Matted body
- Laser printed logo
- Functional plastic stand
- Maner satinat
- Logo imprimat cu laser
- Suport functional din plastic



Размери / Sizes / Dimensiuni:
8, 9, 10, 11, 13, 14, 17, 19mm



Ключ звездогаечен, к-м 12 бр. на стойка / Combination spanners, 12 pcs set / Set 12 chei combinate

art. №	size	box	ctn
233302	6-22 mm	6	18

- Полирана глава
- Матово покритие на тялото
- Лазерно принтирано лого
- Функционална пластмасова стойка
- Polished head
- Matted body
- Laser printed logo
- Functional plastic stand
- Maner satinat
- Logo imprimat cu laser
- Suport functional din plastic



Размери / Sizes / Dimensiuni:
6, 7, 8, 9, 10, 11, 12, 13, 14, 17,
19, 22mm



Ключ лула к-м 8 бр. на стойка / Ring end spanners, 8 pcs set / Set 8 chei inelare

art. №	size	box	ctn
231201	6-22 mm	5	20

- Полирана глава
- Матово покритие на тялото
- Лазерно принтирано лого
- Функционална пластмасова стойка
- Polished head
- Matted body
- Laser printed logo
- Functional plastic stand
- Maner satinat
- Logo imprimat cu laser
- Suport functional din plastic





Ключ звездогаечен с тресчотка / Combination spanner with ratchet / Cheie combinata cu clichet



art. №	size	box	ctn
391001	8 mm	10	100
391002	10 mm	10	100
391003	12 mm	10	100
391004	13 mm	10	100
391005	14 mm	10	100
391006	15 mm	10	100
391007	17 mm	10	100
391008	19 mm	10	100

- Тресчотен механизъм - 72 зъба
- Матово покритие на тялото
- Ratchet mechanism - 72 teeth
- Matted surface
- Mecanism clichet cu 72 dinti
- Suprafata satinata

Ключ звездогаечен с тресчотка, к-м 6 бр., на стойка / Combination spanners with ratchet, 6 pcs set / Set 6 chei combinate cu clichet



art. №	size	box	ctn
391301	8-17 mm	2	20

- Размери: 8, 10, 12, 13, 15, 17mm
- Тресчотен механизъм - 72 зъба
- Матово покритие на тялото
- Функционален пластмасов хенгер

- Sizes: 8, 10, 12, 13, 15, 17mm
- Ratchet mechanism - 72 teeth
- Matted surface
- Functional plastic stand

- Dimensiuni: 8, 10, 12, 13, 15, 17mm
- Mecanism clichet cu 72 dinti
- Material: CR-V
- Suprafata satinata
- Suport functional din plastic

Размери / Sizes / Dimensiuni: 8, 10, 12, 13, 15, 17 mm

Ключове многофункционални, к-м 2 бр. / Swedish type pipe wrench, 2 pcs set / Cleste instalatii, set 2 buc



art. №	size	box	ctn
239910	9-22 mm / 23-32 mm	30	60

Ключ глух с рамо / Box spanner with tommy bar / Cheie tubulara cu levier



art. №	size	box	ctn
231501	8x9mm	100	400
231502	10x11mm	50	200
231503	12x13mm	25	150
231504	14x15mm	25	150
231505	16x17mm	20	120
231506	19x21mm	15	80
231507	20x22mm	20	80
231508	24x27mm	8	48

Ключ глух с рамо, k-m 6 бр / I-type wrench, set 6pcs / Set 6 chei tubulare cu levier

art. №	size	box	ctn
239904	10, 11, 13, 14, 17mm	-	60



Ключ тръбен, двойно рамо с челюсти 45° / Swedish type pipe wrench 45° / Cleste instalator suedez 45°

art. №	size	box	ctn
290707	1"	1	36
290708	1_1/2"	1	24
290709	2"	1	12

- Изработени от висококачествена стомана
- Индукционно закалени зъби
- Извита под 45° челюст
- Гумирана дръжка
- Made from high quality steel
- Hardened teeth
- Curved on 45° jaw
- Rubber covered handles
- Fabricat din otel de calitate
- Dinti caliti
- Falci inclinate la 45°
- Mânere din cauciuc acoperite



Ключ тръбен, двойно рамо с челюсти мул "S" 45° / Swedish type pipe wrench, jaws „S“ 45° / Cleste instalator suedez 45° tip „S“

art.№	size	box	ctn
290701	1"	-	36
290702	1" 1/2"	-	24
290703	2"	-	12

- Изработени от висококачествена стомана
- Индукционно закалени зъби
- Извити под 45° челюсти
- Made from high quality steel
- Hardened teeth
- Curved on 45° jaws
- Fabricat din otel de calitate
- Dinti caliti
- Falci inclinate la 45°



Тръбен ключ двойно рамо / Swedish Type Pipe Wrench / Cleste instalator suedez

art.№	size	box	ctn
290704	1"	-	36
290705	1_1/2"	-	24
290706	2"	3	12

- Изработен от висококачествена стомана
- Индукционно закалени зъби
- Made from high quality steel
- Hardened teeth
- Fabricat din otel inalt aliat
- Dinti caliti

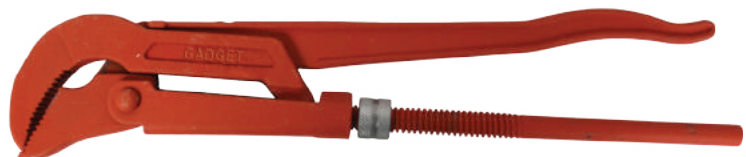



Френску клоч / Adjustable wrench / Cheie reglabila



art.No	size	box	ctn
291105	150mm	6	120
291106	200mm	6	60
291107	250mm	6	60
291108	300mm	6	36

- Изработени от висококачествена стомана
- Хром-никелово покритие, устойчиво на корозия
- Двуконпонентна ергономична дръжка
- Made from high quality steel
- Chromium-Nickel plated surface. Corrosion resistant
- Ergonomic bi-material handle
- Fabricat din otel de calitate
- Placat cu nichel pentru o rezistenta mai buna la coroziune
- Maner bi-material pentru confort in utilizare

Вложка шестостенна 1/2" / Socket 1/2" / Tubulara 1/2"



art.No	size	box	ctn
330501	1/2"x10mm	20	200
330502	1/2"x11mm	20	200
330503	1/2"x12mm	20	200
330504	1/2"x13mm	20	200
330505	1/2"x14mm	20	200
330506	1/2"x15mm	20	200
330507	1/2"x16mm	20	200
330508	1/2"x17mm	18	180
330509	1/2"x18mm	15	150
330510	1/2"x19mm	15	150
330511	1/2"x22mm	20	120
330512	1/2"x24mm	20	80
330513	1/2"x27mm	8	80
330514	1/2"x30mm	6	60
330515	1/2"x32mm	5	50

Вложку торкс 1/2", k-m 9 бр. / Socket Torx 1/2", 9pcs set / Set 9 tubulare Torx 1/2"



art.No	size	box	ctn
330577	1/2"	10	40

- Размери / Sizes / Dimensiuni:
(1/2") E10, E11, E12, E14, E16, E18, E20, E22, E24

Вложку торкс 1/4" & 3/8", k-m 10 бр. / Socket Torx 1/4" & 3/8", 10pcs set / Set 10 tubulare Torx 1/4" & 3/8"



art.No	size	box	ctn
330561	1/4" & 3/8"	5	30

- Размери / Sizes / Dimensiuni:
(1/4"): E4, E5, E6, E7, E8;
(3/8"): E10, E12, E14, E16, E18



Аганмер / Adapter / Adaptor

art.№	size	box	ctn
330550	1/4"Fx3/8"M	20	240
330580	3/8"Fx1/4"M	20	240



Угължение / Wobble extension bar / Adaptor lung

art.№	size	box	ctn
330569	1/2"x125mm	10	80
330570	1/2"x250mm	10	40
330571	1/4"x50mm	40	320
330572	1/4"x75mm	40	320
330573	1/4"x100mm	40	320
330575	3/8"x75mm	30	240



Върток "L" 90° / Handle "L" type 90° / Maner de forta tip L" 90°

art.№	size	box	ctn
330562	1/2"x250mm	6	36
330302	3/4"x350mm	-	20



Върток "L" 105° / Handle "L" type 105° / Maner de forta tip L" 105°

art.№	size	box	ctn
330563	1/2"x320mm	6	36





Върток "Т" / Sliding bar - satin T / Levier strangere satinat "Т"



art.№	size	box	ctn
330564	1/2"x250mm	6	36
330565	1/4"x110mm	20	200

Тресчотка извита / Ratchet handle curved / Clichet maner curbat



art.№	size	box	ctn
330540*	1/4"x145mm	6	60
330541**	3/8"x199mm	6	60
330542**	1/2"x250mm	5	30

- Двуконпонентна дръжка за по-добър захват
- Ergonomic bi-material handle for comfort grip
- Măner de două straturi ergonomic
- *36 зъба / teeth / dinți
- **72 зъба / teeth / dinți

Тресчотка, права гръжка / Ratchet handle - straight / Clichet maner drept.



art. №	size	box	ctn
336501	1/2"x255mm	10	100
336502	1/4"x155mm	5	25
336503	3/8"x210mm	10	50

- Материал: CR-V
- Двупосочен тресчотен механизъм; 45 зъба
- Двуконпонентна, ергономична дръжка
- Material: CR-V
- Two-way ratchet mechanism; 45 teeth
- Bi-material, ergonomic handle
- Material: CR-V
- Mecanism reversibil cu 45 dinti
- Măner ergonomic bi-material

Тресчотка комбинирана / Ratchet handle / Clichet maner drept



art. №	size	box	ctn
336504	1/4" & 3/8" x145mm	10	50

- Материал: CR-V
- Глава с двустранно приложение - за вложки 1/4" и 3/8"
- Двупосочен тресчотен механизъм 72 зъба
- Двуконпонентна, ергономична дръжка
- Material: CR-V
- Two-sided head - 1/4" and 3/8"
- Two-way ratchet mechanism 72 teeth
- Bi-material, ergonomic handle
- Material: CR-V
- Doua dimensiuni de fixare: 1/4" si 3/8"
- Mecanism reversibil cu 72 dinti
- Măner ergonomic bi-material



Тресчотка с вложки, к-м 12 часту / 12pcs Socket wrench set 1/2" / Set 12 tubulare 1/2" 10-24mm

art.№	size	box	ctn
330578	1/2" 10-24mm	5	10

Съдържание / Contents / Continut:

- 1 x 1/2" Тресчотка / Ratchet handle / Surubelnita cu clichet 250mm
- 1 x 1/2" Удължител/Extension bar/Adaptoare lung 125mm
- 10 x 1/2" Вложки/Sockets/Tubulare: 10, 11, 12, 13, 14, 15, 17, 19, 22, 24mm



Комплект инструменти 15 часту / 15pcs Socket wrench set / Set 15 tubulare

art.№	size	box	ctn
330567	3/8" 10-24mm	-	10

Съдържание / Contents / Continut:

- 1 x 3/8" Тресчотка/Ratchet handle/Surubelnita cu clichet 215mm
- 2 x 3/8" Удължители/Extension bar/Adaptoare lung 75mm & 150mm
- 2 x 3/8" Вложки за свещи/Spark plug sockets/Tubulara ptr bujii: 16mm & 21mm
- 10 x 3/8" Вложки/Sockets/Tubulare: 10, 11, 12, 13, 14, 15, 17, 19, 22, 24mm

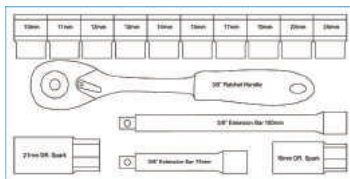

Комплект инструменти 18 часту / 18 pcs Socket wrench set / Set 18 tubulare

art.№	size	box	ctn
330576	1/2" 8-32mm	-	5

Съдържание / Contents / Continut:

- 1 x 1/2" Тресчотка/Ratchet handle/Surubelnita cu clichet 250mm
- 1 x 1/2" Удължител/Extension bar/Adaptoare lung 125mm
- 1 x 1/2" Върток Т-образен/Sliding "T" bar/Levier strangere satin 250mm
- 1 x 1/2" Подвижна свързка/Universal joint/Adaptor tubulare flexibil
- 14 x 1/2" Вложки/Sockets/Tubulare: 8, 10, 11, 12, 13, 14, 15, 17, 19, 22, 24, 27, 30, 32mm

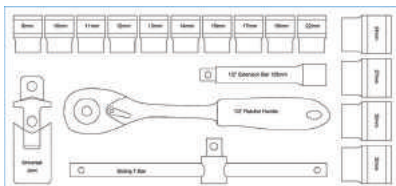



Комплект инструменти, 18 ч., мет. кутия / 18 pcs Socket wrench set / 18 Pcs/Set trusa tubulare



art.№	size	box	ctn
330568	1/4" 4-13mm	-	10

Съдържание / Contents / Continut:

- 1 x 1/4" Тресчотка/Ratchet handle/Surubelnita cu clichet 155mm
- 1 x 1/4" Удължител/Extension bar/Adaptoare lung 100mm
- 1 x 1/4" Върток Т-образен/Sliding "T" bar/Levier strangere satin 110mm
- 1 x 1/4" Подвижна свързка/Universal joint/Adaptor tubulare flexibil
- 12 x 1/4" Вложки/Sockets/Tubulare: 4, 4.5, 5, 5.5, 6, 7, 8, 9, 10, 11, 12, 13mm
- 1 x 1/4" Вложка за крайници/Hex coupler/Imbus furtun

Комплект инструменти 26 части 1/4" / 26pcs Socket wrench set 1/4" / Set 26 tubulare 1/4"



art.№	size	box	ctn
339003	1/4"	-	10

Съдържание / Contents / Continut:

- 1 x 1/4" Тресчотка/Ratchet handle/Surubelnita cu clichet 155mm
- 1 x 1/4" Отвертка за вложки/Spinner handle/Maner ptr tubulare 150mm
- 1 x 1/4" Върток Т-образен/Sliding "T" bar/Levier strangere satin 115mm
- 2 x 1/4" Удължители/Extension bars/Adaptoare lung 50mm & 100mm
- 1 x 1/4" Подвижна свързка/Universal joint/Adaptor tubulare flexibil
- 14 x 1/4" Вложки/Sockets/Tubulare: 4, 4.5, 5, 5.5, 6, 6.5, 7, 8, 9, 10, 11, 12, 13, 14mm
- 5 x 1/4" Дълбоки вложки/Deep sockets/Tubulare profund: 8, 10, 11, 12, 13mm

Комплект инструменти 46 части 1/4" / 46pcs Socket wrench set 1/4" / Set 46 tubulare 1/4"



art.№	size	box	ctn
339004	1/4"	-	10

Съдържание / Contents / Continut:

- 1 x 1/4" Тресчотка/Ratchet handle/Surubelnita cu clichet 155mm
- 1 x 1/4" Отвертка за вложки/Spinner handle/Maner ptr tubulare 150mm
- 1 x 1/4" Върток Т-образен/Sliding "T" bar/Levier strangere satin 115mm
- 2 x 1/4" Удължители/Extension bars/Adaptoare lung 50mm & 100mm
- 1 x 1/4" Гъвкав удължител/Flexible extension/Adaptoare lung flexibil 145mm
- 1 x 1/4" Подвижна свързка/Universal joint/Adaptor tubulare flexibil
- 1 x 1/4" Адаптор за вложки/ADP for sockets/Adaptor ptr tubulare
- 13 x 1/4" Вложки/Sockets/Tubulare: 4, 4.5, 5, 5.5, 6, 7, 8, 9, 10, 11, 12, 13, 14mm
- 21 x 1/4" Вложки с крайници/Bit Sockets/Bit Tubulare: SL4, 5.5, 7mm; PH#1, #2, #3; PZ#1, #2, #3; HEX H3, 4, 5, 6, 7, 8mm; Torx T10, 15, 20, 25, 30, 40
- 3 x Шесторами/HEX keys/Cheie imbus: 1.5, 2, 2.5mm

Комплект инструменти 82 часту 1/4" & 1/2" / 82pcs Socket wrench set 1/4" & 1/2" / Set 82 tubulare

art.No	size	box	ctn
339005	1/4" & 1/2"	-	3

Съдържание / Contents / Continut:

- 2 x Тресчотки/Ratchet handles/Surubelnite cu clichet 1/4"x155mm & 1/2"x260mm
- 1 x 1/4" Отвертка за вложки/Spinner handle/Maner ptr tubulare 150mm
- 2 x 1/4" Удължители/Extension bars/Adaptoare lung 50mm & 100mm
- 1 x 1/4" Гъвкав удължител/Flexible extension/Adaptoare flexibil 145mm
- 2 x 1/2" Удължител/Extension bar/Adaptoare lung 125mm & 250mm
- 1 x 1/4" Върток Т-образен/Sliding "T" bar/Levier strangere satin 115mm
- 2 x Подвижна свързка/Universal joint/Adaptor tubulare flexibil 1/4" & 1/2"
- 1 x 1/4" Адаптор за вложки/ADP for sockets/Adaptor ptr tubulare
- 13 x 1/4" Вложки/Sockets/Tubulare: 4, 4.5, 5, 5.5, 6, 7, 8, 9, 10, 11, 12, 13, 14mm
- 17 x 1/4" Вложки с накр./Bit Sockets/Bit Tubulare: SL4, 5.5, 6.5mm; PH#1, #2; PZ1, 2; HEX H3, 4, 5, 6mm; Torx T8, 10, 15, 20, 25, 30
- 1 x 1/2" Адаптор комбиниран/3-way adaptor/3-way adaptor
- 12 x 1/2" Вложки/Sockets/Tubulare: 14, 15, 16, 17, 18, 19, 20, 22, 24, 27, 30, 32mm
- 2 x 1/2" Вложки за свещи/Spark plug sockets/Tubulara ptr bujii: 16&21mm
- 1 x Вложка за накрайници/Coupler/Cuplor 1/2"-5/16"
- 15 x 5/16" Накрайници/Bits/Biti: SL8, 10, 12mm; PH#3, #4; PZ#3, #4; HEX8, 10, 12, 14mm; Torx T40, 45, 50, 55
- 9 x Ключове звездогаечни: 8, 10, 11, 12, 13, 14, 17, 19, 22mm



Комплект инструменти 94 часту 1/4" & 1/2" / 94pcs Socket wrench set 1/4" & 1/2" / Set 94 tubulare

art.No	size	box	ctn
339006	1/4" & 1/2"	-	3

- 2 x Тресчотки/Ratchet handles/Surubelnite cu clichet 1/4"x155mm & 1/2"x260mm
- 1 x 1/4" Отвертка за вложки/Spinner handle/Maner ptr tubulare 150mm
- 2 x 1/4" Удължители/Extension bars/Adaptoare lung 50mm & 100mm
- 1 x 1/4" Гъвкав удължител/Flexible extension/Adaptoare lung flexibil 145mm
- 2 x 1/2" Удължител/Extension bar/Adaptoare lung 125mm & 250mm
- 1 x 1/4" Върток Т-образен/Sliding "T" bar/Levier strangere satin 115mm
- 2 x Подвижна свързка/Universal joint/Adaptor tubulare flexibil 1/4" & 1/2"
- 1 x 1/4" Адаптор за вложки/ADP for sockets/Adaptor ptr tubulare
- 13 x 1/4" Вложки/Sockets/Tubulare: 4, 4.5, 5, 5.5, 6, 7, 8, 9, 10, 11, 12, 13, 14mm
- 8 x 1/4" Дълбоки вложки/Deer sockets/Tubulare profund: 6, 7, 8, 9, 10, 11, 12, 13mm
- 17 x 1/4" Вложки с накрайници/Bit Sockets/Bit Tubulare: SL4, 5.5, 7mm; PH#1, #2; PZ1, 2; HEX H3, 4, 5, 6mm; Torx T8, 10, 15, 20, 25, 30
- 1 x 1/2" Адаптор комбиниран/3-way adaptor/3-way adaptor
- 18 x 1/2" Вложки/Sockets/Tubulare: 10, 11, 12, 13, 14, 15, 16, 17, 18, 19, 20, 21, 22, 23, 24, 27, 30, 32mm
- 4 x 1/2" Дълбоки вложки/Deer sockets/Tubulare profund: 14, 15, 17, 19mm
- 2 x 1/2" Вложки за свещи/Spark plug sockets/Tubulara ptr bujii: 16mm & 21mm
- 1 x Вложка за накрайници/Coupler/Cuplor 1/2"-5/16"
- 15 x 5/16" Накрайници/Bits/Biti: SL8, 10, 12mm; PH#3, #4; PZ#3, #4; HEX8, 10, 12, 14mm; Torx T40, 45, 50, 55
- 3 x Шестгорамии/HEX keys/Cheie imbus: 1.5, 2, 2.5mm



Комплект инструменти 108 часту 1/4" & 1/2" / 108 pcs Socket wrench set 1/4" & 1/2" / Set 108 tubulare

art.No	size	box	ctn
339007	1/4" & 1/2"	-	3

- 2 x Тресчотки/Ratchet handles/Surubelnite cu clichet 1/4"x155mm & 1/2"x260mm
- 1 x 1/4" Отвертка за вложки/Spinner handle/Maner ptr tubulare 150mm
- 2 x 1/4" Удължители/Extension bars/Adaptoare lung 50mm & 100mm
- 2 x 1/2" Удължител/Extension bar/Adaptoare lung 125mm & 250mm
- 1 x 1/4" Върток Т-образен/Sliding "T" bar/Levier strangere satin 115mm
- 2 x Подвижна свързка/Universal joint/Adaptor tubulare flexibil 1/4" & 1/2"
- 13 x 1/4" Вложки/Sockets/Tubulare: 4, 4.5, 5, 5.5, 6, 7, 8, 9, 10, 11, 12, 13, 14mm
- 8 x 1/4" Дълбоки вложки/Deer sockets/Tubulare profund: 6, 7, 8, 9, 10, 11, 12, 13mm
- 5 x 1/4" Вложки Торкс/Sockets Torx/Tubulare Torx: E4,E5,E6,E7,E8
- 18 x 1/4" Вложки с накрайници/Bit Sockets/Bit Tubulare: SL4, 5.5, 6.5mm; PH#1, #2; PZ#1, #2; HEX H3, 4, 5, 6mm; Torx T8, 10, 15, 20, 25, 27, 30
- 1 x 1/2" Адаптор комбиниран/3-way adaptor/3-way adaptor
- 17 x 1/2" Вложки/Sockets/Tubulare: 10, 11, 12, 13, 14, 15, 16, 17, 18, 19, 20, 21, 22, 24, 27, 30, 32mm
- 5 x 1/2" Дълбоки вложки/Deer sockets/Tubulare profund: 14, 15, 17, 19, 22mm
- 8 x 1/2" Вложки Торкс/Sockets Torx/Tubulare Torx: E10, 11, 12, 14, 16, 18, 20, 24
- 2 x 1/2" Вложки за свещи/Spark plug sockets/Tubulara ptr bujii: 16mm & 21mm
- 1 x Вложка за накрайници/Coupler/Cuplor 1/2"-5/16"
- 17 x 5/16" Накрайници/Bits/Biti: SL8, 10, 12mm; PH#3, #4; PZ3, 4; HEX7, 8, 10, 12, 14mm; Torx T40, 45, 50, 55, 60
- 3 x Шестгорамии/HEX keys/Cheie imbus: 1.5, 2, 2.5mm



Съдържание / Contents / Continut:

Съдържание / Contents / Continut:



Комплект инструменти 216 часту 1/4" & 3/8" & 1/2" / 216 pcs Socket wrench set 1/4" & 3/8" & 1/2" / Set 216 tubulare



art.No	size	box	ctn
339008	1/4" & 3/8" & 1/2"	-	2

- 3 x Тресчотки/Ratchet handles/Surubelnite cu clichet 1/4"x155mm & 3/8"x205mm & 1/2"x260mm
- 1 x 1/4" Отвертка за вложки/Spinner handle/Maner ptr tubulare 150mm
- 1 x 1/4" Отвертка за накрайници/Screwdriver/Surubelnita ptr biti 210mm
- 2 x 1/4" Удължители/Extension bars/Adaptoare lung 50mm & 100mm
- 1 x 3/8" Удължител/Extension bar/Adaptoare lung 125mm
- 2 x 1/2" Удължител/Extension bar/Adaptoare lung 125mm & 250mm
- 1 x 1/4" Върток Т-образен/Sliding "T" bar/Levier strangere satin 115mm
- 3 x Подвижна свързка/Universal joint/Adaptor tubulare flexibil 1/4" & 3/8" & 1/2"
- 1 x 1/4" Адаптор за вложки/ADP for sockets/Adaptor ptr tubulare
- 13 x 1/4" Вложки/Sockets/Tubulare: 4, 4.5, 5, 5.5, 6, 7, 8, 9, 10, 11, 12, 13, 14mm
- 7 x 1/4" Дълбоки вложки/Deep sockets/Tubulare profund: 4, 5, 6, 7, 8, 9, 10mm
- 5 x 1/4" Вложки Торкс/Sockets Torx/Tubulare Torx: E4, E5, E6, E7, E8
- 30 x 1/4" Вложки с накрайници/Bit Sockets/Bit Tubulare: SL4, 5.5, 6.5, 7mm; PH#0, #1, #2; PZ#0, #1, #2; HEX H3, 4, 5, 6mm; Torx T8, 9, 10, 15, 20, 25, 27, 30; Torx (с отвор) TT8, 9, 10, 15, 20, 25, 27, 30
- 10 x 3/8" Вложки/Sockets/Tubulare: 10, 11, 12, 13, 14, 15, 16, 17, 18, 19mm
- 6 x 3/8" Дълбоки вложки/Deep sockets/Tubulare profund: 10, 11, 12, 13, 14, 15mm
- 6 x 3/8" Вложки Торкс/Sockets Torx/Tubulare Torx: E10, 11, 12, 14, 16, 18mm
- 1 x 1/2" Адаптор комбиниран/3-way adaptor/3-way adaptor
- 14 x 1/2" Вложки/Sockets/Tubulare: 13, 14, 15, 16, 17, 18, 19, 20, 21, 22, 24, 27, 30, 32mm
- 5 x 1/2" Дълбоки вложки/Deep sockets/Tubulare profund: 16, 17, 18, 19, 22mm
- 3 x 1/2" Вложки Торкс/Sockets Torx/Tubulare Torx: E20, E22, E24
- 2 x 1/2" Вложки с накрайници/Bit Sockets/Bit Tubulare: H14, T70
- 1 x 3/8" Вложка за свещи/Spark plug socket/Tubulara ptr bujii: 18mm
- 2 x 1/2" Вложки за свещи/Spark plug sockets/Tubulara ptr bujii: 16mm & 21mm
- 3 x Вложки за накрайници/Couplers/Cuploare: 1/4"-1/4"; 3/8"-5/16"; 1/2"-5/16"
- 44 x 1/4" (25mm) Накрайници/Bits/Biti: SL4(x2), 5, 5.5, 6, 8mm; PH#1, #2; PZ#1, #2; HEX H3, 4, 5, 6mm; HEX (с отвор) H3, 4, 5, 6; Torx T8, 10, 15, 20, 25; Torx (с отвор) TT8, 10(x2), 15, 20(x3), 25(x2), 40; Splinn M5, 6, 8; TORQ 6, 8, 10; TRI-WING 1, 2, 3; Square S1, S2
- 30 x 5/16" (30mm) Накрайници/Bits/Biti: SL6, 6.5, 8mm; PH#3, #4; PZ#3, #4; HEX H5.5, 6(x2), 7, 8mm; Torx T25, 27, 30, 35, 40(x2), 45, 50; TT27, 30, 35, 40, 45, 50; Splinn M5, 6, 8, 10;
- 7 x Шестгорамии/HEX keys/Cheie imbus: 1, 1.5, 2, 2.5, 3, 4, 5mm
- 12 x Ключове звездогаечни/Combination spanners/Cheie combinata: 8, 9, 10, 11, 12, 13, 14, 15, 16, 17, 18, 19mm

Количка за инструменти, 6 чекмеджета / Tools cabinet, 6 drawers / Dulap scule 6 sertare echipat

art.No	size	box	ctn
344201	-	-	1

Съдържание / Contents / Continut:

- 1 x 1/2" Тресчотка/Ratchet handle/Surubelnite cu clichet 255 mm
- 17 x 1/2" Вложки/Sockets/Tubulare: 8, 9, 10, 11, 12, 13, 15, 16, 17, 19, 20, 21, 22, 24, 27, 30, 32 mm
- 2 x 1/2" Удължители/Extension bars/Adaptoare lung 125mm & 250 mm
- 1 x 1/2" Върток Т-образен/Sliding "T" bar/Levier strangere satin
- 1 x 1/2" Подвижна свързка/Universal joint/Adaptor tubulare flexibil
- 1 x 3/8" Тресчотка/Ratchet handle/Surubelnite cu clichet 210 mm
- 15 x 3/8" Вложки/Sockets/Tubulare: 8, 9, 10, 11, 12, 13, 14, 15, 16, 17, 18, 19, 21, 22, 24 mm
- 2 x 3/8" Удължители/Extension bars/Adaptoare lung 75mm & 150 mm
- 1 x 3/8" Върток Т-образен/Sliding "T" bar/Levier strangere satin
- 1 x 3/8" Подвижна свързка/Universal joint/Adaptor tubulare flexibil
- 1 x 1/4" Тресчотка/Ratchet handle/Surubelnite cu clichet
- 1 x 1/4" Отвертка за накрайници/Screwdriver/Surubelnita ptr biti 165 mm
- 13 x 1/4" Вложки/Sockets/Tubulare: 4, 4.5, 5, 5.5, 6, 7, 8, 9, 10, 11, 12, 13, 14 mm
- 2 x 1/4" Удължители/Extension bars/Adaptoare lung 50mm & 100 mm
- 1 x 1/4" Върток Т-образен/Sliding "T" bar/Levier strangere satin
- 1 x 1/4" Подвижна свързка/Universal joint/Adaptor tubulare flexibil
- 23 x 1/4" Вложки с накрайници/Bit Sockets/Bit Tubulare: SL4, 5.5, 7mm; PH#1, #2, #3; PZ#1, #2, #3; Torx T8, 10, 15, 20, 25, 27, 30, 40; HEX H3, 4, 5, 6, 7, 8 mm;
- 9 x 1/4" Дълбоки вложки/Deep sockets/Tubulare profund: 5, 6, 7, 8, 9, 10, 11, 12, 13 mm
- 9 x Шестгорамии/HEX keys/Cheie imbus: 1.5, 2, 2.5, 3, 4, 5, 6, 8, 10 mm
- 13 x Ключове звездогаечни с тресчотка/Ratchet combination spanners/Cheie combinata cu clichet: 8, 9, 10, 11, 12, 13, 14, 15, 16, 17, 18, 19, 20 mm
- 6 x Отвертки/Screwdrivers/Surubelnite Phillips: PH0*75 mm, PH1*100mm, PH2*38 mm, PH2*100 mm, PH3*150 mm, PH4*200 mm;
- 6 x Отвертки, плоски/Screwdrivers slotted/Surubelnite dreapte: SL3*75mm, SL4*100 mm, SL 5.5*100mm, SL6*38mm, SL6.5*150mm, SL8*175 mm;
- 6 x Шестгорамии Т-дръжка/HEX keys T-handle/Cheie imbus, manner T: 2.0*100 mm, 2.5*100mm, 3.0*100mm, 4.0*150mm, 5.0*150mm, 6.0*150 mm;
- 1 x Клещи комбиниранни/Combination pliers/Cleste combinat 200 mm
- 1 x Клещи резачки/Diagonal cutting pliers/Cleste sfic 200 mm
- 1 x Клещи дългоусти/Long nose pliers/Cleste varf lung 200 mm
- 1 x Клещи "гарга" / Water pump pliers/Cleste papagal 250 mm
- 1 x Клещи "чирак" / Locking pliers/Cleste autoblocant 250 mm
- 4 x Клещи зерер/Snap ring pliers/Clesti sigurante: 2 x прави (отварящи, затварящи)/straight (opening/closing), 2 x закривени 90° (отварящи, затварящи)/bent nose 90° (opening/closing).



*стрианен шкаф с рафт

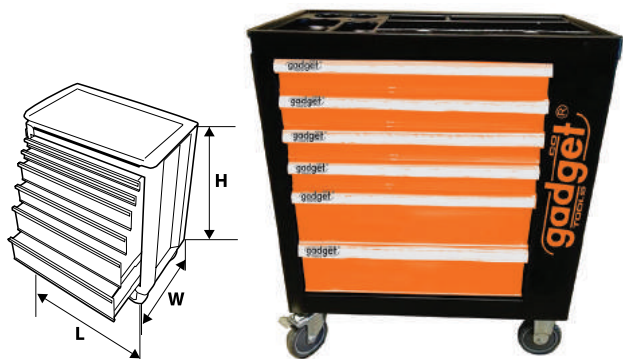

Overall Size / Размери

H	W	L
900 mm	480 mm	790 mm

Комплект инструменти 21 часту 3/4" / 21pcs Socket wrench set 3/4" / Set 21 tubulare 3/4"



art.№	size	box	ctn
330523	3/4"	-	2

- 1 Тресчотка /Ratchet handle / Surubelnita cu clichet 495 mm
- 1 Върток Т образен / Sliding T bar / Levier strangere satin: 456mm
- 2 Удължения / Extension bars / Adaptoare lung: 100, 200 mm
- 16 Вложки / Sockets / Tubulare: 19, 21, 22, 23, 24, 26, 27, 30, 32, 34, 36, 38, 41, 46, 48, 50 mm

Комплект инструменти 26 часту 3/4" & 1" 21-65 mm / Set 26 tubulare 3/4" & 1" 21-65 mm



art.№	size	box	ctn
330522	3/4"&1"	-	1

- 1 x 3/4" Тресчотка/Ratchet handle/Surubelnita cu clichet
- 1 x 3/4" Върток Т-образен/Sliding "T" bar/Levier strangere satin 520 mm
- 1 x Подвижна свързка / Universal joint / Adaptor tubulare flexibil
- 1 x Адаптор/ADP/Adaptor 3/4"F-1"M
- 2 x Удължители/Extension bars/Adaptoare lung: 190 mm; 52 mm
- 20 - Вложки / Sockets / Tubulare: 21, 22, 23, 24, 26, 27, 28, 29, 30, 31, 32, 34, 36, 38, 41, 46, 50, 55, 60, 65mm

Ролетка автостоп, гума / Measuring tape, autostop, rubber coated / Ruleta cauciucata cu autostop

art.№	size	box	ctn
260720	3m x 16mm		
260721	5m x 19mm	12	120
260723	7.5m x 25mm		

- Материал: гума + пластмаса
- Автостоп функция
- Накрайник с двоен магнит, странично издължен профил
- Тринитово захващане на магнита
- Оригинален дизайн с обемно лого
- Material; rubber+plastic
- Autostop function
- Double magnet with side-extended profile
- Magnet fixation with 3 rivets
- Original design with 3D logo
- Material; cauciuc+plastic
- Functie Autostop
- Magnet dublu cu profil actiune pe ambele fete
- Magnet fixat cu trei nituri
- Design original cu logo 3D



• MAGNETIC END

Ролетка с гума / Measuring tape, rubber coated / Ruleta cauciucata

art.№	size	box	ctn
260711	3m x 16mm	12	180
260712	5m x 19mm	12	120
260713	5m x 25mm	12	120
260714	7.5m x 25mm	12	60

- Предпазващо гумено покритие
- Заклучващ механизъм
- Намагнетизиран накрайник
- Shock absorption rubber cover
- Locking mechanism
- Magnetic end
- Imbracat in cauciuc pentru o mai buna absorbtie a socurilor
- Sistem de blocare
- Cap magnetic



• MAGNETIC END

Ролетка пластмасова, автостоп / Measuring tape ABS case, autostop / Ruleta carcasa ABS cu autostop

art.№	size	box	ctn
260307	3m x 16mm	12	120
260308	5m x 19mm	12	120
260309	5m x 25mm	12	120
260310	7.5m x 25mm	6	60

- Материал на тялото - висококачествена пластмаса
- Автостоп функция
- "CE" сертификати за прецизност на измерването
- Body material - ABS
- Autostop function
- "CE" certificates for measurement precision
- Material - ABS
- Functie Autostop
- Certificat "CE" -precizie masurare



Нивелир с водачи / Level / Nivelă AL



art.№	size	box	ctn
270701	300mm	-	60
270702	400mm	-	60
270703	500mm	-	60
270704	600mm	-	60
270705	800mm	-	60
270706	1000mm	-	60
270707	1200mm	-	30
270708	1500mm	-	30

- Алюминиево тяло
- 3 либели
- Точност на измерване: 1mm/m
- Alluminum body; 3 vials; Measuring precision: 1mm/m
- Corp din aluminiu; 3 cilindri cu bule de aer;
- Precizie: 1mm/m

Нивелир алуминиев с магнит / Level aluminium magnetic / Nivelă aluminiu magnetica



art.№	size	box	ctn
270510	300mm	-	60
270511	400mm	-	60
270512	500mm	-	60
270513	600mm	-	60
270514	800mm	-	60
270515	1000mm	-	60

- Алюминиево тяло с 2бр. магнити; 3 либели
- Точност на измерване: 1mm/m
- Гумирани, удароустойчиви краища
- Alluminum body with 2 magnets; 3 vials
- Measuring precision: 1mm/m
- Rubber, shock-resistant side ends
- Corp din aluminiu cu 2 magneti; 3 cilindri cu bule de aer
- Precizie: 1mm/m; Protectii de cauciuc anti-soc la capete

Мастар алуминиев, скосен / Level special, aluminum, trapezium / Dreptar , aluminiu, trapezoidal



art. №	size	box	ctn
271201	1000mm	-	10
271202	1500mm	-	10
271203	2000mm	-	10
271204	2500mm	-	10

- Материал на тялото: алуминий
- Трапецовиден профил
- Body material: aluminum
- Trapezium profile
- Corp din aluminiu
- Profil trapez

Мастар алуминиев с либели и ръкохватки / Level special, aluminum with vials and handles / Dreptar, Al. cu manere si nivel



art. №	size	box	ctn
271205	1500mm	-	10
271206	2000mm	-	10
271207	2500mm	-	10

- Материал на тялото: алуминий
- 2 либели
- Body material: aluminum
- 2 vials
- Corp din aluminiu
- 2 cilindri cu bule de aer

Бъгъл прав, алуминиев / Try square, aluminum / Echer Al

art. №	size	box	ctn
280901	250mm	6	72
280902	300mm	6	72
280903	350mm	6	72
280904	400mm	6	48

- 4-странна измервателна скала
- Възможност за измерване на 45 градуса.
- Висока прецизност на измерване
- Материал - алуминий; Отвор за закачане
- Плътна дръжка с усилен профил
- 4-sided measuring scale; Material- aluminum
- Option for measuring 45 degr. angle
- High-precision measuring; Hanging hole on the body
- Dense handle with strong profile
- Rigla pe 4 fete; Cu taietura oblica la 45°
- Masurare de precizie; Material:aluminu



Бъгъл прав, метален, монолитен / Iron framing Try square / Echer metal monolitic

art. №	size	box	ctn
280905	20*30cm	12	120
280906	40*60cm	12	36

- Стоманено тяло
- 4-странна измервателна скала по две оси - дължина и ширина
- High quality steel body
- 4-sided measuring scale on both axes - length and width
- Material: Otel
- Scala de masurare pe toate cele 4 parti, pe ambele axe - lungime si latime



Бъгъл прав, метален, монолитен / Iron framing Try square / Echer metal monolitic

art. №	size	box	ctn
280801	160mm	30	150

- Измервателни скали: метрична (0-160mm); инчова (0-6")
- Възможност за външно измерване, външно измерване и измерване на дълбочина
- Graduation: metric (0-160mm) and Imperial (0-6")
- Three-way measurement: inside, outside, depth
- Sisteme de masurare: metric (0-160mm) si in inch (0-6")
- 3 tipuri de masuratori: interior, exterior si adancime



Луфтомер / Tickness gauge / Trusa lere

art.№	size	box	ctn
339906	0.05-1.00mm	6	120

- Размери / Sizes / Dimensiuni:
- 0.05, 0.15, 0.20, 0.25, 0.30, 0.40, 0.50, 0.60, 0.70, 0.80, 0.90, 1.00mm





Фазомер / Voltage tester / Creion tensiune



art.№	size	box	ctn
280815	3x60mm	25	500

- Подходящ за тестване на AC напрежение от 100-500V
- Suitable for testing AC voltage 100-500V
- Potrivit pentru verificare prezenta tensiune alternativa intre 100-500V

Фазомер / Voltage tester / Creion tensiune



art.№	size	box	ctn
280816	4x125mm	25	500

- Подходящ за тестване на AC напрежение от 100-500V
- Suitable for testing AC voltage 100-500V
- Potrivit pentru verificare prezenta tensiune alternativa intre 100-500V

Чук с дървена гръжка / Hammer with wooden handle / Ciocan lacatus cu maner lemn



art. №	size	box	ctn
240301	100g	12	120
240302	200g	12	72
240303	300g	6	60
240304	500g	6	36
240305	800g	6	24
240306	1000g	6	18
240307	1500g	6	12
240308	2000g	6	12

- Глава от закалена стомана
- Кръгъл нит за по-добро фиксиране на главата
- Удобна дървена гръжка
- Head of hardened steel
- Round rivet for better fixation of the head
- Ergonomic wooden handle
- Cap din otel calit
- Nit rotund pentru o mai bună fixare
- Maner comod din lemn

Чук с метална гръжка / Hammer with tubular metal handle / Ciocan maner metal + fibra



art.№	size	box	ctn
240362	300g	6	48
240363	500g	6	48
240364	800g	6	24

- Глава от закалена стомана
- Метална гръжка с гумено покритие в основата
- Head of hardened steel
- Metal handle with rubber cover
- Din otel calit
- Coada ergonomica din otel



Чук с гръжка TPR / Hammer TPR handle / Ciocan maner TPR

art.№	size	box	ctn
240340	100g	12	60
240341	200g	6	60
240342	300g	6	60
240343	500g	6	24
240344	800g	6	24
240345	1000g	6	24
240346	1500g	6	12
240347	2000g	6	12

- Глава от закалена стомана
- Ергономична TPR дръжка за по-сигурен захват
- Head of hardened steel
- Ergonomic TPR handle for better grip
- Din otel calit
- Coadă ergonomica din plastic TPR



Чук с гръжка фибростъкло / Machinist hammer, fiberglass handle / Ciocan lacatus cu maner fibra

art. №	size	box	ctn
242601	3kg	-	6
242602	5kg	-	4
242603	8kg	-	2
242604	10kg	-	2

- Глава от закалена стомана
- Удобна дълга дръжка- фибростъкло
- Head of hardened steel
- Comfortable long handle- fiberglass
- Din otel calit
- Coadă ergonomica lunga din fibra de sticla



Чук кофражистки, трикомпонентна гръжка / Roofing hammer, three-material handle / Ciocan dulgher

art.№	size	box	ctn
243101	600g	6	24

- Глава от закалена стомана с магнитен канал за пирони
- Ергономична трикомпонентна дръжка за повече комфорт при работа
- Head of hardened steel with magnetized channel for nails
- Ergonomic 3-material handle for better comfort.
- Din otel calit
- Maner din 3 materiale pentru aderenta sporita
- Suport magnetic pentru cuie



Чук кофражистки с метална гръжка / Roofing hammer with tubular metal handle / Ciocan dulgher

art.№	size	box	ctn
249905	600g	6	24

- Глава от закалена стомана
- Канал за пирони на главата
- Метална дръжка с гумено покритие в основата
- Head of hardened steel
- Channel for nails on the head
- Metal handle with rubber cover
- Din otel calit
- Coadă ergonomica din otel cu protectie din cauciuc
- Profil suport pentru cuie





Чук мун "козу крак" с метална гръжка / Claw hammer, tubular metal handle / Ciocan dulgher maner metal+fibra



art.№	size	box	ctn
249907	600g	6	24

- Глава от закалена стомана
- Метална дръжка с гумено покритие в основата
- Head of hardened steel
- Metal handle with rubber cover
- Din otel calit
- Coadă ergonomică din metal cu protecție din cauciuc

Чук зигарски с метална гръжка / Manson hammer R type, metal handle / Ciocan zidar cu coada metalica



art.№	size	box	ctn
249904	600g	6	24

- Глава от закалена стомана
- Метална дръжка с гумено покритие в основата
- Head of hardened steel
- Metal handle with rubber cover
- Din otel calit
- Coadă ergonomică din metal cu protecție din cauciuc

Чук гумен с гръжка TPR, черен / Rubber mallet, TPR handle, black / Ciocan cauciuc negu, maner TPR



art.№	size	box	ctn
241150	340g	-	60
241151	445g	-	50
241152	680g	-	24
241153	900g	-	20

- Глава от високоеластичен каучук
- Ергономична TPR дръжка за удобен захват
- Rubber head
- Ergonomic TPR handle for better grip
- Cap din cauciuc
- Coadă ergonomică din plastic TPR

Чук гумен с гръжка TPR, бял / Rubber mallet, TPR handle, white / Ciocan cauciuc alb, maner TPR



art.№	size	box	ctn
241154	340g	-	60
241155	445g	-	50
241156	680g	-	24
241157	900g	-	20

- Глава от високоеластичен каучук
- Ергономична TPR дръжка за удобен захват
- Rubber head
- Ergonomic TPR handle
- Cap din cauciuc
- Coadă ergonomică din plastic TPR

Чук пластмасов, метална гръжка / Hammer plastic/rubber end, metal handle / Ciocan calciuc plastic, maner metal



art. №	size	box	ctn
241168	30mm	10	60
241169*	35mm	10	60

- Сменящи се накрайници на главата - пластмасов и гумен
- Ергономична метална дръжка с гумено покритие в основата
- Replaceable head ends - plastic and rubber
- Ergonomic metal handle with rubber cover
- Capete demontabilă- plastic și cauciuc
- Coadă ergonomică din metal cu protecție din cauciuc

241169*





Чук зумен с метална гръжка, бял / Rubber mallet with metal handle, white / Ciocan cauciuc alb, maner metal

art.№	size	box	ctn
241158	340g	-	60

- Глава от високоеластичен каучук
- Ергономична метална дръжка с гумено покритие в основата
- Rubber head
- Ergonomic metal handle with rubber cover
- Cap din cauciuc
- Coada ergonomica din metal cu protectie din cauciuc



Чук зумен с дървена гръжка, бял / White rubber mallet, wooden handle / Ciocan cauciuc alb, maner lemn

art. №	size	box	ctn
241160	340g	-	60
249910	680g	-	24

- Глава от високоеластичен каучук
- Rubber head
- Cap din cauciuc



Брадва с гръжка фибростъкло / Axe with fiberglass handle / Topor maner fibra

art.№	size	box	ctn
381349	400g	-	24
381350	500g	-	24
381351	600g	-	24
381352	800g	-	24
381353	1000g	-	24
381354	1250g	-	12
381355	1500g	-	12
381356	1800g	-	6
381357	2000g	-	6

- Глава от закалена стомана
- Ергономична дръжка от фибростъкло
- Head of hardened steel
- Ergonomic fiberglass handle
- Din otel calit
- Coada ergonomică din fibră de sticlă



Трион за дърво, закален / Hand saw, hardened / Fierastrau, cu dinti caliti

art. №	size	box	ctn
372501	400mm	10	60
372502	450mm	10	60
372503	500mm	10	60

- Закалени, тристранно заточени зъби
- Двуконпонентна, ергономична дръжка
- Измервателна линия на острието
- Three-way sharpened teeth
- Additionally hardened teeth
- Bi-material, ergonomic handle
- Measuring scale on top of the blade
- Dinti ascuțiti în 3 unghiuri, și caliti pentru duritate sporită
- Maner ergonomic bi-material
- Lama de tăiere cu rigla gradată





Трион кръгов / Compass Saw / Fierastru pentru lemn



art.№	size	box	ctn
371734	300mm	-	60

- Тяло от висококачествена закалена стомана
- Двустранно заточени зъби
- Ергономична двукомпонентна дръжка за удобен захват
- Saw blade made of high quality steel
- Hardened teeth for long lasting sharpness
- Ergonomic confort grip handle
- Lama de taire fabricata din otel inalt aliat
- Dinti caliti pentru o durata de utilizare mai mare
- Maner ergonomic

Бичкия / Garden Bow Saw / Ferestru coarba



art.№	size	box	ctn
371321	525mm	-	24
371322	600mm	-	24
371323	750mm	-	24

- Двустранно заточени зъби
- Ергономична пластмасова дръжка за удобен захват
- Винтов фиксатор на острието
- Hardened teeth for long lasting sharpness
- Ergonomic confort grip handle
- Fixation screw for the blade
- Dinti caliti pentru o durata de utilizare mai mare
- Maner ergonomic
- Şurub de fixare pentru lama

Лист за бичкия / Bow saw blade / Lama ferestru coarba



art.№	size	box	ctn
371305	525mm	20	240
371306	600mm	20	240
371307	750mm	20	240
371308	900mm	20	240

- Двустранно заточени зъби
- Hardened teeth for long lasting sharpness
- Dinti caliti pentru o durata de utilizare mai mare

Ножовка с лист, двукомпонентна дръжка / Hacksaw frame, bi-material handle / Bomfaier maner bi-material



art.№	size	box	ctn
371115	300mm	12	48

- Двустранно заточени зъби
- Ергономична двукомпонентна дръжка
- Винтов фиксатор на острието
- Hardened teeth for long lasting sharpness
- Ergonomic confort plastic handle
- Fixation screw for the blade
- Dinti caliti pentru o durata de utilizare mai mare
- Maner ergonomic din plastic
- Şurub de fixare pentru lama



Ножовка с лист, метална гръжка / Hacksaw frame, metal handle / Bomfaier, maner metalic

art.№	size	box	ctn
371116	300mm	-	48

- Двустранно заточени зъби
- Метална дръжка
- Винтов фиксатор на острието
- Hardened teeth for long lasting sharpness
- Metal handle
- Fixation screw for the blade
- Dinti caliti pentru o durata de utilizare mai mare
- Mâner de metal
- Şurub de fixare pentru lama



Ножовка комбинирана "3 в 1" / Garden Saw "3 in 1" / Fierastru multifunctional "3 in 1"

art.№	size	box	ctn
371320	-	-	24

- Остриета за дърво и за метал
- Двустранно заточени зъби
- Ергономична пластмасова дръжка за удобен захват
- Винтов фиксатор за смяна и твърдост на остриетата
- Blades for wood and for metal
- Hardened teeth for long lasting sharpness
- Ergonomic confort grip handle
- Fixation screw for changing and tightening the blades
- Dinti caliti pentru o durata de utilizare mai mare
- Maner ergonomic din plastic
- Lama pentru lemn si metal
- Şurub de schimbare si strangere lama



Нож макетен метална глава и 3 рез. / Utility knife with 3 blades / Cutter multifunctional cu 3 lame

art.№	size	box	ctn
370107	18x165mm	24	240

- Стоманен водач на резеца
- Заклучващ механизъм
- Прецизно заточен резец
- Гумиран корпус за удобен захват
- 2 резервни ножчета
- Blade guide made of stainless steel
- Safety lock; Precision sharpened snap-off cutter
- Rubber covered body for better grip
- 2 spare blades
- Ghidaj lama fabricat din otel inoxidabil
- Blocaj de siguranta; Maner din cauciuc
- 2 lame de rezerva
- Lama ascutita cu precizie



Нож макетен с винтов фиксатор, ергономичен / Utility knife with twist-lock, ergonomic / Cutter cu sina metalica, ergonomice

art.№	size	box	ctn
370201	18x155mm	12	144

- Гумиран корпус с ергономична форма
- Прецизно заточен резец
- Метален водач на острието
- Rubber covered body, ergonomically shaped
- Precision sharpened snap-off cutter
- Metal guide of the blade
- Protectie de cauciuc, forma ergonomica
- Lama ascutita cu precizie
- Ghidaj lama fabricat din metal





Нож макетен с винтов фуксамор / Utility knife with twist lock / Cutter cu sina metalica



art. №	size	box	ctn
370204	18x155mm	12	144

- Гумиран корпус с ергономична форма
- Прецизно заточен резец
- Метален водач на острието
- Rubber covered body, ergonomically shaped
- Precision sharpened snap-off cutter
- Metal guide of the blade
- Protecție de cauciuc, forma ergonomică
- Lama ascutita cu precizie
- Ghidaj lama fabricat din metal

Нож макетен - метално тяло / Utility knife - metal body / Cutter cu sina metalica



art. №	size	box	ctn
370202	18x155mm	12	144

- Алюминиево тяло
- Метален водач на острието
- Aluminum body
- Metal guide of the blade
- Corp din aluminiu
- Ghidaj lama fabricat din metal

Нож макетен, съвбаем с 10 рез./ Utility knife, foldable with 10 blades/ Cutter multifunctional, pliabil cu 10 lame



art. №	size	box	ctn
370203		12	72

- Метално тяло с гумирано покритие
- 10 бр. резервни остриета в кутийка
- Механизъм за бърза смяна на острието
- Пластмасов предпазител на острието
- Щипка за закачане
- Metal body, rubber covered
- 10 spare blades in a box
- Quick release button for the blade
- Plastic protector for the blade; Hanging clip
- Corp din metal, cu protectie de cauciuc
- 10 lame de rezerva
- Buton pentru eliberarea rapida a lamei
- Protecție din plastic pentru lama

Резец нож макет, кутмия 10 бр. / All-purpose knife blades, set 10 pcs / Rezerve lame cutter, 10 bic

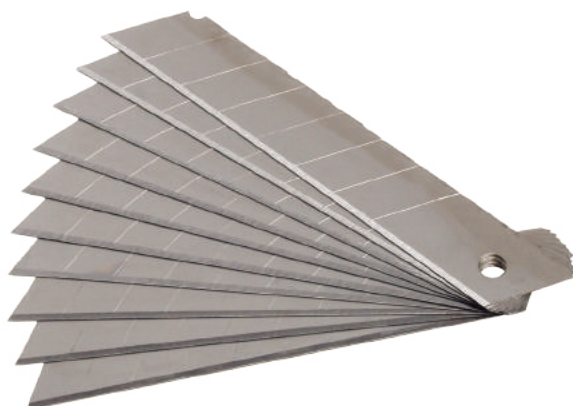

art. №	size	box	ctn
370114	18x100mm	20	300

- Закалени 7 сегментни резци
- Heavy duty blades 7 snap - off elements
- Lama pentru utilizare intensa cu 7 segmente



Елмаз JOBO / Glass Cutter JOBO / Diamant taiere geamuri

art.№	size	box	ctn
499907	-	12	600



Резци за гърборезба, k-m 13 бр. / Carving tools set 13pcs / Set 13 cutite taiere

art.№	size	box	ctn
359901	-	-	100



Ножица за PVC тръбу / PVC pipe cutter / Foarfeca taiat tevi PVC

art.№	size	box	ctn
291301	42mm	10	50

- Излято метално тяло
- Прецизно заточено триъгълно острие от неръждаема стомана
- Ергономични дръжки за удобен захват
- Автоматично отваряне; Заклучващ лост
- Durable dye-cast metal body
- Precision sharpened triangle blade, stainless steel
- Ergonomic handles for comfortable grip
- Automatic opening; Locking lever
- Corp din metal turnat
- Lama din otel inoxidabil in forma de triunghi, ascutita cu precizie; Manere ergonomice
- Deschidere automata; Maneta de blocare



Ножица за PVC тръбу / PVC Pipe Cutter / Foarfeca taiat tevi PVC

art.№	size	box	ctn
290313	36mm	6	24

- Метално тяло
- Автоматично отваряне
- Прецизно заострен нож от неръждаема стомана
- Metal body
- Automatic opening
- Stainless steel knife
- Corp metalic
- Deschidere automata
- Cutit din otel inoxidabil





Тръборез / Pipe Cutter / Dispozitiv taiat tevi

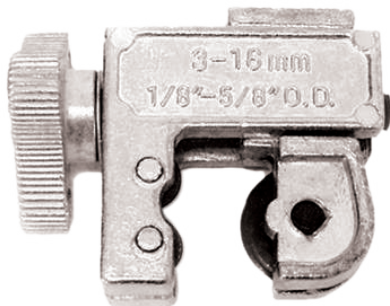

art.No	size	box	ctn
290306	3-16mm	10	100

- Метално тяло
- Metal body
- Corp metallic

Тръборез / Pipe Cutter / Dispozitiv taiat tevi

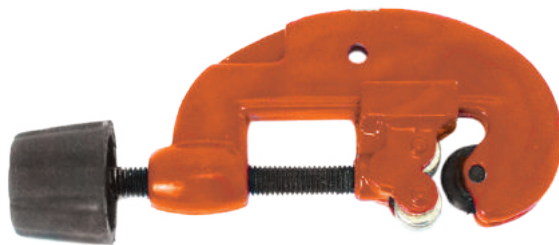

art.No	size	box	ctn
290307	3-28mm	10	50

- Метално тяло
- Metal body
- Corp metallic

Тръборез / Pipe Cutter / Dispozitiv taiat tevi



art.No	size	box	ctn
290310	6-64mm	-	20

- Метално тяло
- Metal body
- Corp metallic

Ножица за арматура / Heavy-duty bolt cutter / Cleste taiat bolturi



art.No	size	box	ctn
370903	450mm	-	20
370904	600mm	-	10
370905	750mm	-	6

- Челюсти, изработени от висококачествена стомана
- Минимално усилие при рязане
- Head made by high quality steel
- Minimum effort by cutting
- Falci din otel de calitate
- Taiere cu minim de efort



Ножица за ламарина, права / Tin snips, straight / Foarfeca tabla

art.№	size	box	ctn
370717	250mm	6	60

- Двучовково предаване на движението при рязане
- Ергономични, двукомпонентни дръжки – пластмаса и гума
- Удобно заключване с една ръка
- Double pivot action for high cutting power
- Ergonomic, bi-material handles – plastic and rubber
- Easy lock with one hand
- Acționare cu două axe pentru amplificarea forței de tăiere
- Mânere bi-material pentru aderență sporită
- Blocare facila cu o singura mana



Ножица за ламарина, дясно рязане / Tin snips, right cut / Foarfeca tabla cu taiere pe dreapta

art.№	size	box	ctn
370718	250mm	10	60

- Двучовково предаване на движението при рязане
- Ергономични, двукомпонентни дръжки – пластмаса и гума
- Удобно заключване с една ръка
- Double pivot action for high cutting power
- Ergonomic, bi-material handles – plastic and rubber
- Easy lock with one hand
- Acționare cu două axe pentru amplificarea forței de tăiere
- Mânere bi-material pentru aderență sporită
- Blocare facila cu o singura mana



Ножица за ламарина, ляво рязане / Tin snips, left cut / Foarfeca tabla cu taiere pe stanga

art.№	size	box	ctn
370719	250mm	6	60

- Двучовково предаване на движението при рязане
- Ергономични, двукомпонентни дръжки – пластмаса и гума
- Удобно заключване с една ръка
- Double pivot action for high cutting power
- Ergonomic, bi-material handles – plastic and rubber
- Easy lock with one hand
- Acționare cu două axe pentru amplificarea forței de tăiere
- Mânere bi-material pentru aderență sporită
- Blocare facila cu o singura mana





Стяга гърводелска, гвуконп. гръжка / F-clamp, bi-material handle / Presa manuala, maner bi-material



art. №	size	box	ctn
250120	50x150mm	-	50
250121	50x200mm	-	50
250122	50x250mm	-	50
250123	50x300mm	-	50
250124	80x300mm	-	25
250125	120x500mm	-	10
250126	120x800mm	-	10

- Материал на тялото - висококач. въглеродна стомана
- Удобна двукомпонентна дръжка - пластмаса и гума
- Material of the body - high quality carbon steel
- Comfortable bi-material handle - plastic and rubber
- Fabricat din otel-carbon de calitate
- Mânere bi-material pentru aderență sporită

Стяга бърз захват "2 в 1" / F-clamp speed type "2 in 1" / Presa prindere rapida "2 in 1"



art. №	size	box	ctn
250505	150mm	-	20
250604	200mm	-	20
250601	300mm	-	20
250602	450mm	-	20
250603	600mm	-	20

- Затваряща и отваряща функция
- "Пистолетен" механизъм за работа с една ръка
- Бутон за бързо освобождаване
- Фиксиращ винт при смяна на функциите
- Closing and opening function
- "Pistol" mechanism for one hand work
- Quick-release button
- Fixation screw when changing functions
- Functii de strangere si indepartare
- Mecanism tip pistol pentru actionare cu o singura mana
- Buton pentru eliberare rapida
- Surub limitator pentru schimbarea functiilor

Длемо / Wood chisel / Dalta lemn



art.№	size	box	ctn
350311	10mm	10	100
350313	14mm	10	100
350315	18mm	10	100
350316	22mm	10	100
350317	24mm	10	100

- Изработено от висококачествена Cr-V стомана
- Ергономична двукомпонентна дръжка за удобен захват
- Made by high quality Cr-V steel
- Ergonomic bi-material handle for comfortable grip
- Fabricat din otel inalt aliat Cr-V
- Maner ergonomic pentru o prindere mai buna

Длета гърводелски, к-м 4бр./ Wood chisels, 4pcs set / Dalti pentru lemn, set 4pcs



art.№	size	box	ctn
350310	10, 12, 16, 18mm	10	20

- Изработено от висококачествена Cr-V стомана
- Ергономична двукомпонентна дръжка за удобен захват
- Made by high quality Cr-V steel
- Ergonomic bi-material handle for comfortable grip
- Fabricat din otel inalt aliat Cr-V
- Maner ergonomic pentru o prindere mai buna



Длето секач с гвукомп. триъгълна гръжка / Chisel flat head bi-material triang. handle / Dalta plata cu protectie

art.No	size	box	ctn
329930	16x300mm	6	36

- Ширина на резаца: 24mm
- Двуконпонентна триъгълна дръжка за по-добър захват
- Твърд предпазител за безопасна работа
- Cutter width: 24mm
- Bi-material triangular handle for comfortable grip
- Hard safety guard for safer work
- Latime varf: 24mm
- Maner ergonomic pentru o prindere mai buna
- Protectie pentru operare in siguranta



Длето остро с гвукомп. триъгълна гръжка / Chisel pointed head, bi-material triang. handle / Dalta ascutita cu protectie

art.No	size	box	ctn
329931	Φ16x300mm	6	36

- Двуконпонентна триъгълна дръжка за по-добър захват
- Твърд предпазител за безопасна работа
- Bi-material triangular handle for comfortable grip
- Hard safety guard for safer work
- Maner ergonomic pentru o prindere mai buna
- Protectie pentru operare in siguranta



Длето секач с гвукомп. гръжка с прегназумел / Chisel flat head, bi-material hand guard / Dalta plata cu protectie

art.No	size	box	ctn
329933	16x300mm	6	36

- Ширина на резаца: 22mm
- Двуконпонентна дръжка за по-добър захват
- Твърд предпазител за безопасна работа
- Cutter width: 22mm
- Bi-material handle for comfortable grip
- Hard safety guard for safer work
- Latime varf: 22mm
- Maner ergonomic pentru o prindere mai buna
- Protectie pentru operare in siguranta



Длето остро с гвукомп. гр. с прегназумел / Chisel pointed head, bi-material hand guard / Dalta ascutita cu protectie

art.No	size	box	ctn
329934	Φ16x300mm	6	36

- Двуконпонентна дръжка за по-добър захват
- Твърд предпазител за безопасна работа
- Bi-material handle for comfortable grip
- Hard safety guard for safety work
- Maner ergonomic pentru o prindere mai buna
- Protectie pentru operare in siguranta





Пила за дърво, обла / File for wood, round / Pila rotunda pt lemn



art.№	size	box	ctn
360112	200 mm	12	120

- Изработена от висококачествена стомана
- Ергономична двукомпонентна дръжка за удобен захват
- Made by high quality steel
- Ergonomic bi-material handle for comfortable grip
- Fabricata din otel de calitate
- Maner ergonomic pentru o prindere mai buna

Пила за дърво, плоска / File for wood, flat / Pila plata pt lemn



art.№	size	box	ctn
360113	200 mm	12	120

- Изработена от висококачествена стомана
- Ергономична двукомпонентна дръжка за удобен захват
- Made by high quality steel
- Ergonomic bi-material handle for comfortable grip
- Fabricata din otel de calitate
- Maner ergonomic pentru o prindere mai buna

Пила за дърво, полуобла / File for wood, half round / Pila semirotunda pt lemn



art.№	size	box	ctn
360114	200 mm	12	120

- Изработена от висококачествена стомана
- Ергономична двукомпонентна дръжка за удобен захват
- Made by high quality steel
- Ergonomic bi-material handle for comfortable grip
- Fabricata din otel de calitate
- Maner ergonomic pentru o prindere mai buna

Пили за дърво, к-м 3 броя / File for wood, 3pcs set / Set 3 pile pt lemn



art.№	size	box	ctn
360115	200 mm	20	40

- Изработена от висококачествена стомана
- Ергономична двукомпонентна дръжка за удобен захват
- Made by high quality steel
- Ergonomic bi-material handle for comfortable grip
- Fabricata din otel de calitate
- Maner ergonomic pentru o prindere mai buna



Пила за метал, обла / File for metal, round / Pila rotunda pt metal

art.№	size	box	ctn
360704	200 mm	12	120

- Изработена от висококачествена въглеродна стомана
- Ергономична двукомпонентна дръжка за удобен захват
- Made by high quality steel
- Ergonomic bi-material handle for comfortable grip
- Fabricata din otel de calitate
- Maner ergonomic pentru o prindere mai buna



Пила за метал, плоска / File for metal, flat / Pila plata pt metal

art.№	size	box	ctn
360705	200 mm	12	120

- Изработена от висококачествена въглеродна стомана
- Ергономична двукомпонентна дръжка за удобен захват
- Made by high quality carbon steel
- Ergonomic bi-material handle for comfortable grip
- Fabricata din otel carbon de calitate
- Maner ergonomic pentru o prindere mai buna



Пила за метал, полуобла / File for metal half round / Pila semirotunda pt metal

art.№	size	box	ctn
360706	200 mm	12	120

- Изработена от висококачествена въглеродна стомана
- Ергономична двукомпонентна дръжка за удобен захват
- Made by high quality carbon steel
- Ergonomic bi-material handle for comfortable grip
- Fabricata din otel carbon de calitate
- Maner ergonomic pentru o prindere mai buna



Пили за метал, k-m 3бр / File for metal, 3pcs set / Set 3 pile pt metal

art.№	size	box	ctn
360707	200 mm	20	40

- Изработена от висококачествена въглеродна стомана
- Ергономична двукомпонентна дръжка за удобен захват
- Made by high quality carbon steel
- Ergonomic bi-material handle for comfortable grip
- Fabricata din otel carbon de calitate
- Maner ergonomic pentru o prindere mai buna

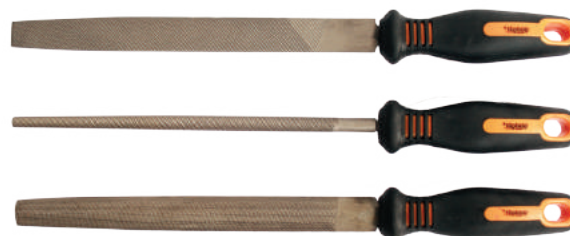



Четка телена, пластм. гръжка / Steel wire brush, plastic handle / Perie sarma, maner plastic

art.№	size	box	ctn
340503	-	12	120



Четка телена със стъргалка / Steel wire brush with scraper / Perie sarma cu razuiitor

art.№	size	box	ctn
340505	-	10	120



- Пластмасово тяло
- Метална стъргалка на върха
- Plastic body
- Steel scraper on the top
- Corp din plastic
- Lama din otel pentru raziure

Четки за почистване, малки 3 бр. / Mini wire brushes, 3pcs set / Set 3 mini perii sarma

art.№	size	box	ctn
340504	-	-	120



- Предназначени за фино почистване на тесни пространства
- Материал на дръжката: пластмаса
- Материали на почистващите нишки: стомана; мед; пластмаса
- For fine cleaning of narrow spaces
- Handle material: plastic
- Threads material: stainless steel, copper, plastic
- Pentru folosirea in spatii inguste
- Manere din plastic
- Fire din otel inoxidabil, alama si plastic

О-пръстени, к-м 407 бр. / O-ring assortment, 407pcs set / Set 407 garnituri

art.№	size	box	ctn
540704	-	-	20



Менгеме въртящо / Bench vice, swivel base / Menghina de banc cu baza pivotanta

art.№	size	box	ctn
310108	75mm / 4.5kg	1	4
310107	100mm / 5kg	1	-
310109	125mm / 7.5kg	1	-
310110	150mm / 11.2kg	1	-

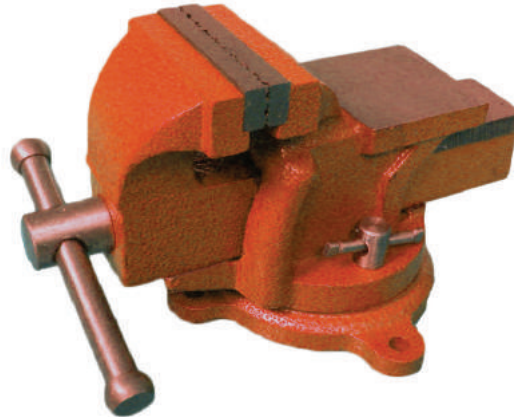

Менгеме настолно, въртящо / Bench vice mini, swivel base / Menghina cu baza pivotanta

art.№	size	box	ctn
310302	50mm	1	20
310303	60mm	1	20
310304	75mm	1	20



Такер метален / Staple gun, metal / Capsator, metal

art.№	size	box	ctn
491105	4-14 mm	10	20

- Подсилено стоманено тяло
- Натсройка на височината на отвора
- Reinforced steel body
- Adjustable driving force
- Corp ranforsat din otel
- Forta de apasare reglabila



Скоби за такер, кутия 1000 бр. / Staples 1000 pcs/set / Set 1000 buc Capse tapiterie

art.№	size	box	ctn
511301	6mm	-	200
511302	8mm	-	200
511303	10mm	-	200
511304	12mm	-	200
511305	14mm	-	200

- Тип 53
- Type 53
- Tip 53



Размер / Size / Dimensiune





Нитачка лостова / Hand riveter, long arm / Cleste pop nituri frontal

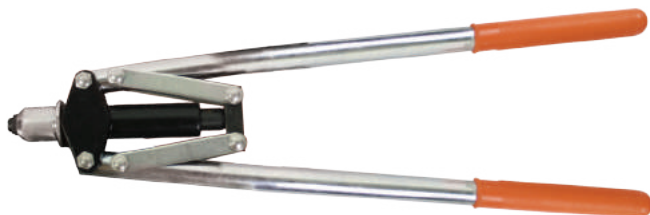

art.№	size	box	ctn
491150	430mm	1	15

- За алуминиеви нитове до 5 mm.
- Дълги дръжки за по-голям натиск
- Накрайници и ключ закрепени за тялото на нитачката
- For AL rivets up to 5mm
- Long handles for high pressure
- Nozzles and key afixed to the body
- Pentru nituri AL de până la 5 mm
- Manere lungi pentru o putere mai mare
- Capete de nituire si cheie fixate pe corpul pistolului

Нитачка с нитове в кутия / Hand riveter with pop rivets, box / Cleste pop nituri cu pop nituri



art.№	size	box	ctn
491152	250mm	12	24

- За алуминиеви нитове до 4 mm.
- Глава от висококачествена стомана
- 4бр. накрайници и ключ, закрепени към тялото на нитачката
- Удобни пластмасови дръжки
- 20 бр. нитове
- For AL rivets up to 4 mm
- Head from high quality steel
- 4pcs nozzles and key attached to the body
- Comfortable plastic handles
- 20pcs blind rivets
- Pentru nituri AL de până la 4 mm
- Cap fabricat din otel de calitate
- 4 capete de nituire si cheie fixate pe corpul pistolului
- Manere confortabile din plastic
- 20 pop-nituri

Нитачка с подвижна на 90° глава / Hand riveter with swivel head 90° / Cleste pop nituri cap pivotant 90°

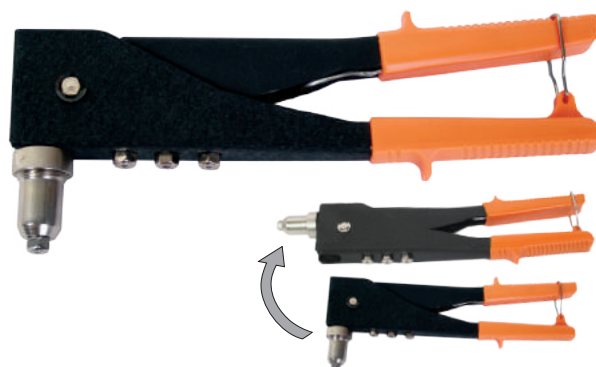

art.№	size	box	ctn
491151	270mm	6	24

- За алуминиеви нитове до 4 mm.
- Глава от висококачествена стомана
- 4бр. накрайници и ключ, закрепени към тялото на нитачката
- Въртяща глава на 90°, осигуряваща достъп до трудно достъпни места
- Удобни пластмасови дръжки
- For AL rivets up to 4 mm
- Head from high quality steel
- 4pcs nozzles and key attached to the body
- 90° revolving head for hardly accessible places
- Comfortable plastic handles
- Pentru nituri AL de până la 4 mm
- Cap fabricat din otel de calitate
- 4 capete de nituire si cheie fixate pe corpul pistolului
- Manere confortabile din plastic
- Cap pivotant 90° pentru spatii greu accesibile

Нитачка с въртяща на 360° глава / Hand riveter with swivel head 360° / Cleste pop nituri frontal cap pivotant 360°



art.№	size	box	ctn
491154	300mm	6	24

- За алуминиеви нитове до 4 mm.
- Глава от висококачествена стомана
- 4бр. накрайници и ключ, закрепени към тялото на нитачката
- Въртяща глава на 360°, осигуряваща достъп до трудно достъпни места
- Удобни пластмасови дръжки
- For AL rivets up to 4 mm
- Head from high quality steel
- 4pcs nozzles and key attached to the body
- 360° revolving head for hardly accessible places
- Comfortable plastic handles
- Pentru nituri AL de până la 4 mm
- Cap fabricat din otel de calitate
- 4 capete de nituire si cheie fixate pe corpul pistolului
- Manere confortabile din plastic
- Cap pivotant 360° pentru spatii greu accesibile

Вакуум за стъкла, алуминиев / Suction lifter, aluminium / Ventuza transport geamuri-metal

art.№	size	box	ctn
499932	-	1	60



Вакуум за стъкла, двоен, алуминиев / Suction lifter, double, aluminium / Ventuza transport geamuri dubla-metal

art.№	size	box	ctn
499933	-	1	24



Лебедка с колан / Ratchet tie down / Chinga ancorare cu carlig

art.№	size	box	ctn
300501	25mm x 4.5m	-	72
300503	50mm x 8m	-	24
300505	50mm x 8m	-	12

Максимална товароносимост / Max load / Incarcare maxima:

- 00501 - 100kg
- 300503 - 1t
- 300505 - 2t



Лебедка с колан, k-m 4 бр. / Ratchet tie down, 4pcs set / Set 4 chingi cu carlig

art.№	size	box	ctn
300504	25mm x 3m	-	12

- Дължина на коланите: 3m
- Ширина на коланите: 25mm
- Максимална товароносимост: 300kg
- Length of belts: 3m
- Width of belts : 25mm
- Max load: 300kg
- Lungime : 3m
- Latime : 25mm
- Incarcare maxima : 300kg



Лебедка с въже / Hand cable winch / Sctipete manual

art.№	size	box	ctn
300301	500kg	-	8

- Дължина: 8m
- Максимална товароносимост: 500kg
- Length : 8m
- Max load : 500kg
- Lungime: 10m
- Incărcare maximă : 500kg



Лебедка с въже / Hand cable winch / Scripete manual



art.№	size	box	ctn
300302	4.5mm x 178cm	-	8

- Дължина / Length / Lungime: 1.8 m
- Максимална товараносимост / Max load / Incărcare maximă: 2t

Лебедка с въже, 2 зъба и 3 куку / Hand cable winch, 2 theet 3 hooks / Scripete manual



art.№	size	box	ctn
300303	5.0mm x 228cm	-	6

- Дължина / Length / Lungime: 2.5 m
- Максимална товараносимост / Max load / Incărcare maximă: 2t

Ключ за ржанги, телескопичен / Telescopic wheel wrench / Cheie tubulara cu levier



art.№	size	box	ctn
332007	17x19x21x23mm	-	20

Ключ кръстат / Way wheel nut wrench / Cheie roti



art.№	size	box	ctn
332009	17x19x21x23mm	-	20

Ключ за свещи / Spark plug socket - satin / Cheie bujii - satin



art.№	size	box	ctn
331501	16/21mm	10	50

gadget TOOLS
BASIC SKILLCO
topStrong
ТорСтронг
ТорГарден премиум
МАК LON
topchrome
BAUKRAFT
GREEN TOOLS

Скоба за лагери, двураменна / Bearing puller-two Legs / Extractor 2 picioare

art.№	size	box	ctn
332206	3"/75mm	1	40
332207	4"/100mm	1	30

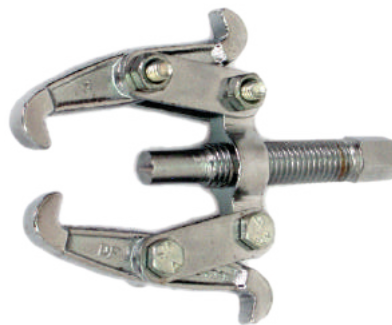

Скоба за лагери тринаменна / Bearing Puller-Three Legs / Extractor 3 picioare

art.№	size	box	ctn
332212	3"/75mm	1	30
332213	4"/100mm	1	24
332214	6"/150mm	1	20
332215	8"/200mm	1	8
332216	10"/250mm	1	6
332217	12"/300mm	1	4



Скоба за сегменти / Piston ring compressor / Presa segmenti

art.№	size	box	ctn
332209	3"/75mm 53-125mm	1	50



Скоби за пружини / Spring clamp / Presa pentru arcuri auto

art.№	size	box	ctn
332208	370mm	1	12





Щанга тун "козу крак" / Wrecking bar / Ranga scos cuie



art.№	size	box	ctn
350701	16x450mm	-	30
350702	16x600mm	-	24
350703	16x750mm	-	24

- Шестостенно тяло, изработено от стомана
- Steel body
- Otel forjat

Компресор за помпане на гуми с манометър / Mini air compressor 12V with a manometer /
Mini compresor 12V cu manometru



art.№	size	box	ctn
120106	12V	-	20

- Работно напрежение: 12V; Дебит: 4.5 l/min
- Макс. налягане: 9 bar
- Захранване от автомобилна запалка
- 3 допълнителни накрайника
- Work voltage: 12V; Air flow: 4.5 l/min; Max pressure: 9bar
- Car lighter plug; 3 additional adaptors
- Tensiune de lucru: 12V; Flux de aer: 4.5 l/min
- Presiune: 9 bar; Stecker pentru bricheta auto
- 3 adaptoare suplimentare

Кабели за стартов ток / Booster cable / Set cabluri pornire

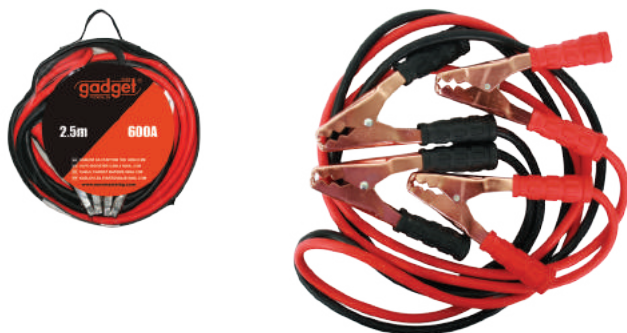

art.№	size	box	ctn
339952	600A / 2.5m	-	10
339953	800A / 3.0m	-	10
339954	1200A / 3.5m	-	8

Въже за теглене / Nylon tow rope / Sufa tractare, nylon



art.№	size	box	ctn
339950	12mm x 3.6m	-	20

- Дължина / Length / Lungime: 3.6m
- Сила на теглене / Pulling force load / Forța de tracțiune: 2t
- Дебелина на въжето / Rope thickness / Grosime de coarda: Ø12mm

Такаламът с гъвкав накрайник / Grease gun / Decalimetru



art.№	size	box	ctn
499925	500cm ³	1	15





Лампа работна с 2 светлини / Work light / Lanterna LED cu magnet

art.№	LED	box	ctn
905001	36pcs	12	24

- Две светлини (36LED / 0.5W)
- Подвижна поставка с магнит (завъртане до 180°)
- Допълнителен магнит на гърба
- Кука за закачане; Материла: ABS
- Батерии: 3x AA (невключени в опаковката)
- Two lights (36LED / 0.5W)
- Movable stand with magnet (up to 180° turning angle); Additional magnet on the back
- Hook for hanging; Material: ABS
- Batteries: 3x AA (not included in the pack)
- Doua lampi (36LED / 0.5W)
- Suport mobil cu magnet (pivotant la 180°)
- Magnet additional pe spatele lanternei



Фенерче 6 LED, с форма на пусалка / Light 6LED, pen shaped / Lanterna cu 6 leduri, tip stilou

art.№	LED	box	ctn
905002	6pcs	25	100

- 6 LED
- Компактна форма
- Функционално закачане
- Батерии: 3x AAA (невключени в опаковката)
- 6 LED
- Compact shape
- Functional hanging
- Batteries: 3x AAA (not included in the pack)
- 6 Led-uri
- Forma compacta
- Baterii: 3xAAA (nu sunt incluse in pachet)



Челник LED / Headlight LED / Lanterna frontala LED

art.№	box	ctn
904901	60	240

- 4 режима на работа
- силна/слаба бяла светлина
- статична/мигаща червена светлина
- Регулируем наклон на осветяване, до 80°.
- Батерии: 3x AAA (невключени в опаковката)
- 4 lighting modes
- intense/faint white light
- static/blinking red light
- Adjustable lighting angle - up to 80°
- Batteries: 3x Aaa (not included in the pack)
- 4 moduri de iluminare:
- lumina alba de intensitate ridicata/redua
- lumina rosie continua/intermitenta
- Unghi de iluminare reglabil - pana la 80°
- Baterii: 3xAAA (nu sunt incluse in pachet)



Фенер 9 светлострелка / Flash light 9 LED / Lanterna 9 LED

art.№	LED	box	ctn
904601	9	24	480

- 9 LED
- Светлинен поток с интензитет от 12000mcd
- Алуминиево тяло
- Батерии 3x AAA (невключени в цената)
- 9 LED
- Luminous flux 1200mcd
- Aluminium body
- Batteries: 3xAAA (not included)
- 9 LED-uri stralucitoare
- Flux luminos: 1200mcd
- Confectionata din aluminiu
- Baterii: 3xAAA (nu sunt incluse in pachet)





Органајзер мини, пластмасов / Organizer ABS, mini / Organizator ABS, mini



art. №	departments отделения	box	ctn
461204	8		54
461205	12		40

- Твррд материал, устојчив на натиск
- Компактна, удобна за пренасяне кутия
- Матов, полупрозрачен капак
- Отвор за закључване
- Dense ABS material, pressure resistant
- Compact box, comfortable for carrying
- Matted cap
- Locking hole
- Material dens din ABS, rezistent la presiune
- Forma compacta, confortabila la transport
- Capac mat

Органајзер с подвижни преграду / Organizer ABS, movable separators / Organizator ABS cu separatoare reglabile



art. №	dimensions размери	depart. отделения	box	ctn
461201	320x265x50mm	21	-	4
461202	380x300x60mm	21	-	16
461203	480x375x75mm	24	-	10

- Функционални отделения с възможност за промяна на размера.
- Functional departments with changeable size.
- Compartimente reglabile

Куфар за инструменти / Tools case / Trusa scule



art. №	size	box	ctn
462408	13"	-	12
462409	16"	-	12
462410	19"	-	9

- Висококачествен материал на изработка
- Функционални отделения на капак
- Органајзер с грапава поврхност
- Удобна заоблена држјка
- High quality material
- Functional compartments of the cap
- Organizer with rough bottom
- Comfortable rounded handle
- Realizata din material rezistent
- Compartimente functionale pe capac
- Cutie cu baza dura
- Maner rotunjit pentru transportare confortabila

Куфар за инструменти, метален / Metal tools case / Trusa scule metal



art. №	size	box	ctn
499939	17"	-	4

- Механизми с подвижни рафтове
- Здрави метални држјки за пренасяне
- Отвори за закључване
- Movable shelves
- Strong metal handles for carrying
- Locking hole
- Rafturi mobile
- Manere metalice solide
- Posibilitate de incuiere cu lacat

Катинар за джукрила Брама / H type brass padlock / Lacat inchidere orizontala tip H

art.№	size	box	ctn
509909	70mm	12	48
509908	80mm	12	48
509907	90mm	12	48

- Многослойна ключалка против шперцови ключове
- Допълнителна защита на ключалката, против разпробиване
- Рамо от подсилена стомана, против срязване и счупване
- Multi-layer lock against key picks
- Additional protection of the lock against drilling
- Hardened shoulder against cutting or breaking
- Incuietoare multi-strat
- Protectie suplimentara impotriva gauririi
- Veriga din material calit impotriva taierii sau spargerii



Катинар защитено рамо / Padlock, protected arm / Lacat metal

art.№	size	box	ctn
500713	50mm	12	72
500714	60mm	12	48
500715	70mm	12	48

- Многослойна ключалка против шперцови ключове
- Допълнителна защита на ключалката, против разпробиване
- Рамо от подсилена стомана, против срязване и счупване
- Multi-layer lock against key picks
- Additional protection of the lock against drilling
- Hardened shoulder against cutting or breaking
- Incuietoare multi-strat
- Protectie suplimentara impotriva gauririi
- Veriga din material calit impotriva taierii sau spargerii



Катинар месинг защитено рамо / Brass Padlock / Lacat bronz

art.№	size	box	ctn
500716	50mm	12	72
500717	60mm	12	48
500718	70mm	12	72

- Многослойна ключалка против шперцови ключове
- Допълнителна защита на ключалката, против разпробиване
- Рамо от подсилена стомана, против срязване и счупване
- Multi-layer lock against key picks
- Additional protection of the lock against drilling
- Hardened shoulder against cutting or breaking
- Incuietoare multi-strat
- Protectie suplimentara impotriva gauririi
- Veriga din material calit impotriva taierii sau spargerii



Пинсети, k-m 4 броя / Tweezers, 4pcs set / Set 4 pensete

art.№	size	box	ctn
930232	-	-	300



BASIC SKILLCO



www.basic.bg

BASIC SKILLCO – най-младия бранд в портфолиото на „Евромастер Импорт/Експорт“, отговаря еднозначно на дилемата пред неопитния клиент: „Толкова много евтини ръчни инструменти! Кой да избира?“ – **BASIC**, разбира се!

Марката включва добре познати, утвърдили се във времето артикули на безопасационно ниска цена. Стилният, изчистен дизайн изпраща своето послание, че професионализма се постига с опита, а **BASIC SKILLCO** е перфектната първа стъпка към това. Той е предпочитана покупка за всеки начинаещ майстор-любител. Покупка, чиито ползи се крият в ръцете на много бъдещи таланти.

BASIC SKILLCO – the newest brand in the “Euromaster I/E” portfolio, answers clearly to the inexperienced user facing the common dilemma: “So many cheap hand tools! Which one should I choose?” – **BASIC**, of course! The brand includes well-known products on a peremptory low price. Its refined and simple design sends a message to the customers: “Professionalism can be achieved only by experience and **BASIC SKILLCO** is the perfect initial step on that way”. The products are the preferred choice for every beginner craftsman. The real profit of this purchase is hidden in the skilled hands of many future talents.

BASIC SKILLCO – cel mai nou brand din portofoliul lui “Euromaster Import Export” SRL este răspunsul unic la dilema clientului fără experiența: “Atât de multe produse ieftine! Pe care să-l aleg?” – **BASIC SKILLCO**, bineînțeles!

Marca include produse bine cunoscute, care s-au impus cu timpul, la un preț mic fără precedent. Designul simplu dar cu stil trimite mesajul său că: „Profesionalismul este atins prin experiența!”, iar **BASIC SKILLCO** este primul pas perfect în această direcție. Este produsul preferat, în vederea achizitiei, de către orice meșter începător. Profitul real al acestei achizitii este ascuns în mâinile unor talente viitoare.

Ключ звездогаечен / Combination Spanners / Cheie combinata

art.№	size	box	ctn
230703	8mm	10	1000
230705	10mm	120	480
230707	12mm	100	400
230708	13mm	60	240
230710	15mm	50	200
230712	17mm	50	200
230714	19mm	5	120



Ключ глух / L-Type Wrench / Cheie Tip L

art.№	size	box	ctn
231302	10mm	-	100
231303	13mm	40	160
231305*	14mm	10	150
231306* (двустранен)	17mm	-	-
231307	17mm	-	50
231308* (двустранен)	19mm	0	0
231309	19mm	10	50
231311*	22mm	20	40
231313	24mm	5	50
231314*	27mm	5	25

*Трайно намалена цена / Sale price / Pret de vanzare



Ключ гаечен, к-т на стойка / D.O.E. spanners, set / Cheie fixa, set

art.№	pcs	size	box	ctn
239921	8	6-22 mm	10	40
239922	12	6-32 mm	4	16



Ключ звездогаечен, к-т на стойка / Combination spanners, set / Chei combinate, set

art.№	pcs	size	box	ctn
239923	8	8-19 mm	10	40
239924	12	6-22 mm	5	20





Ключ звездогачен, к-м 14 бр. на стойка / Combination spanners, 14 pcs set / Set 14 chei combinate



art.№	pcs	size	box	ctn
239906	14	6-32mm	2	8

- Размер / Size / Dimensiune:
6, 8, 10, 11, 12, 13, 14, 17, 19, 22, 24, 27, 30, 32mm

Ключ лула, к-м 8 бр на стойка / Ring end spanners, 8 pcs set / Set 8 chei inelare



art.№	pcs	size	box	ctn
239925	8	6-22 mm	5	20

Шестограми, к-м 10 бр. / Hex key wrenches, 10 pcs set / Set 10 chei imbus



art.№	size	box	ctn
390303	1.5-8mm	-	100

- Размер / Size / Dimensiune:
1.5, 2, 2.5, 3, 3.5, 4, 5, 5.5, 6, 8mm

Отвертки часовничарски, к-м 6 бр. / Precision screwdrivers, 6 pcs set / Set 6 surubelnite precizie



art.№	size	box	ctn
225301	-	-	200

- Размер / Size / Dimensiune:
 x4 1.4, 2.0, 2.4, 3.0mm
 x2 #0, #1

Отвертки часовничарски, к-м 11 бр./ Precision screwdrivers, 11 pcs set / Set 11 surubelnite precizie



art.№	size	box	ctn
225302	-	-	120

- Размер / Size / Dimensiune:
 x6 1, 1.2, 1.4, 1.8, 2.4, 3.0mm
 x3 #00, #0, #1
 x2 AWL



Отвертки дълги точни, к-м 6 бр. / Long precision screwdrivers, 6 pcs set / Set 6 surubelnite precizie lungi

art.№	size	box	ctn
225202	-	-	200

• Размер / Size / Dimensiune:



3x165, 3x190, 3x240 mm



PH1x165, PH1x190, PH1x240 mm



Отвертка "Т" с накрайници и вложки, к-м 21 часту / Screwdriver T-handle with bits & sockets, 21 pcs/set / Surubelnita maner "T" cu biti si tubulare, set 21 piese

art.№	size	box	ctn
330558	-	-	100

T-Образна отвертка за накрайници / T-type bits screwdriver
Şurubelniţă de tip "T"



9 x 1/4" Вложки/Sockets/Tubulare: 4, 4.5, 5, 5.5, 7, 8, 9, 10, 12mm



1 x 1/4" Адаптор за вложки / ADP for sockets / Adaptor ptr tubulare



2 x Накрайници/Bits/Biti SL: 4.5, 5.5mm



2 x Накрайници/Bits/Biti PH: #1, #2



2 x Накрайници/Bits/Biti: PZ2, PZ3



2 x Накрайници/Bits/Biti Torx: T2, T3



2 x Накрайници/Bits/Biti HEX: H2, 3 mm



Отвертка с накрайници и вложки, к-м 25 часту / Screwdriver with bits & sockets, 25 pcs/set / Surubelnita cu biti si tubulare, set 25 piese

art.№	size	box	ctn
229919	-	-	60



1 x 1/4" Отвертка за накрайници/
Screwdriver/Surubelnptr biti: 190mm



1 x 1/4" Адаптор за вложки/ADP for
sockets/Adaptor ptr tubulare



7 x 1/4" Вложки/Sockets/Tubulare:
4, 5, 6, 6.5, 7, 8, 9 mm



• Накрайници / Bits / Biti:



4 x SL: 4, 5, 6, 7mm



4 x PH: #0, #1, #2, #3



4 x PZ: #0, #1, #2, #3



2 x Torx: T15, T25



2 x HEX: H4, 5 mm



Отвертка с накрайници и вложки, к-м 28 часту / Screwdriver with bits & sockets, 28 pcs/set / Surubelnita cu biti si tubulare, set 28 piese

art.№	size	box	ctn
330557	-	-	60



1 x 1/4" Отвертка за накрайници/
Screwdriver/Surubelnptr biti: 170 mm



1 x 1/4" Адаптор за вложки/ADP for
sockets/Adaptor ptr tubulare



10 x 1/4" Вложки/Sockets/Tubulare: 4,
5, 6, 7, 8, 9, 10, 11, 12, 13 mm



• Накрайници / Bits / Biti:



4 x SL: 3, 4, 5, 7mm



3 x PH: #1, #2, #3



4 x Torx: T20, T25, T30, T40



4 x HEX: H3, H4, H5, H7 mm





Отвертка-тресчотка с накр. и вложки, к-м 40 часту / Ratchet w. bits, sockets, 40 pcs/set, blow case / Surubelnita cu biti si tubulare, set 40 piese



art.No	size	box	ctn
330525	-	-	24

- 1 x 1/4" Тресчотка 5-позиционна/5-way Ratchet handle/Surubelnita cu clichet 5 moduri
- 1 x 1/4" Удължител за накрайници/Extension bar/Adaptoare lung 60mm
- 1 x 1/4" Адаптор за вложки/ADP for sockets/Adaptor ptr tubulare
- 7 x Вложки/Sockets/Tubulare: 4, 5, 5.5, 6, 7, 8, 9mm
- 7 x Вложки/Sockets/Tubulare: 3/16", 1/4", 5/16", 11/32", 5/32", 7/32", 9/32"
- 3 x Накрайници/Bits/Biti SL: 3/16", 1/4", 9/32"
- 3 x Накрайници/Bits/Biti PH: #1, #2, #3
- 7 x Накрайници/Bits/Biti Torx: T10, 15, 20, 25, 27, 30, 40
- 8 x Накрайници/Bits/Biti HEX: H1/16", 5/64", 3/32", 1/8", 5/32", 5/16", 7/32", 1/4"
- 2 x Накрайници квадрат/Bits/Biti: S1, S2

Отвертка-тресчотка с накрайници, к-м 45 часту / Ratchet & bits, 45 pcs/set / Surubelnita cu clichet cu biti, set 45 piese



art.No	size	box	ctn
390506	-	-	20

- 1 x 1/4" Тресчотка/Ratchet handle/Surubelnita cu clichet 160 mm
- 1 x 1/4" Удължител за накрайници/Extension bar/Adaptoare lung 60 mm
- 7 x Вложки/Sockets/Tubulare: 5, 6, 7, 8, 9, 10, 11 mm
- 5 x 25 mm Накрайници/Bits/Biti SL: 5, 6(x3), 7 mm
- 4 x 50 mm Накрайници/Bits/Biti SL: 5, 6(x2), 7 mm
- 11 x Накрайници/Bits/Biti PH: #1(25 mm; 50 mm), #2 (25 mm x 5; 50 mm x2), #3 (25 mm; 50 mm)
- 4 x 25 mm Накрайници/Bits/Biti Pozi: PZ1, 2(x2), 3
- 4 x 25 mm Накрайници/Bits/Biti Torx: T10, T15(x2), T20
- 5 x 25 mm Накрайници квадрат/Bits/Biti: S1, S2(x3), S3
- 3 x 50 mm Накрайници квадрат/Bits/Biti: S1, S2, S3

Отвертка-тресчотка с накрайници и вложки, к-м 78 часту / Ratchet w. bits & sockets, 78pcs/set / Surubelnita cu clichet cu biti si tubulare, set 78 piese











art.No	size	box	ctn
330556	-	-	10

- 1 x 1/4" Тресчотка/Ratchet handle/Surubelnita cu clichet 170mm
- 1 x 1/4" Адаптор за вложки/ADP for sockets/Adaptor ptr tubulare 60mm
- 1 x 1/4" Удължител за накрайници/Extension bar/Adaptoare lung 60mm
- 11 x 1/4" Вложки/Sockets/Tubulare: 5/32", 7/32", 3/16", 1/4", 9/32", 5/16", 11/32", 3/8", 13/32", 7/16", 1/2"
- 12 x 25mm Накрайници/Bits/Biti SL: 3, 4, 5, 6, 7, 8mm; 1/8", 5/32", 3/16", 1/4", 9/32", 5/16"
- 3 x 50mm Накрайници/Bits/Biti SL: 5/32", 3/16", 1/4"
- 16 x 25mm Накрайници/Bits/Biti PH: #0(x4), #1(x6), #2(x6)
- 3 x 50mm Накрайници/Bits/Biti PH: #1, #2, #3
- 8 x 25mm Накрайници/Bits/Biti Torx: T10, T15, T20, T25, T27, T30, T40, T45
- 18 x 25mm Накрайници/Bits/Biti HEX: 4, 5, 5.5, 6, 7, 8mm; 1/16", 5/84", 1/8(x2)", 9/64", 3/32", 5/32"(x2), 3/16(x2)", 7/32", 1/4"
- 4 x 25mm Накрайници квадрат/Bits/Biti: S1, S2, S3, S4



Тресчотка с Вложки, k-м 39 часту 1/4" & 3/8" / 39pcs Socket wrench set 1/4" & 3/8" / Set 39 tubulare











art.No	size	box	ctn
330532	1/4" & 3/8" 4-15mm	-	20

-  1 x 3/8" Тресчотка/Ratchet handle/Surubelnita cu clichet 200mm
-  1 x 3/8" Удължител/Extension bar/Adaptoare lung 70mm
-  1 x Адаптор/ADP/Adaptor 3/8"F-1/4"M
-  14 x 1/4" Вложки/Sockets/Tubulare: 4, 4.5, 5, 5.5, 6, 6.5, 7, 7.5, 8, 9, 10, 11, 12, 13mm
-  14 x 1/4" Вложки/Sockets/Tubulare: 5/32", 3/16", 1/4", 7/32", 9/32", 5/16", 11/32", 3/8", 13/32", 7/16", 15/32", 1/2", 17/32", 9/16"
-  3 x 1/4" Вложки/Sockets/Tubulare: 1/4", 5/16", 3/8"
-  2 x 3/8" Вложки/Sockets/Tubulare: 14, 15mm
-  2 x 3/8" Вложки/Sockets/Tubulare: 9/16", 5/8"



Комплект инструменти 40 часту 1/4" & 3/8", мем. кум. / 40pcs Socket wrench set 1/4" & 3/8", metal box / Set 40 tubulare 1/4" si 3/8", cutie metalica











art.No	size	box	ctn
330552	1/4"&3/8" 4-16mm	-	10

-  1 x 3/8" Тресчотка/Ratchet handle/Surubelnita cu clichet 200mm
-  1 x 1/4" Отвертка за вложки/Spinner handle/Surubelnita ptr tubulare 140mm
-  1 x 3/8" Удължител/Extension bar/Adaptoare lung 65mm
-  1 x Адаптор/ADP/Adaptor 3/8"F-1/4"M
-  1 x 3/8" Вложка за свещи/Spark plug socket/Tubulara ptr bujii: 13/16(21mm)
-  1 x 3/8" Диск/Disk/Disk
-  2 x 3/8" Вложки/Sockets/Tubulare: 15, 16mm
-  14 x 1/4" Вложки/Sockets/Tubulare: 4, 4.5, 5, 5.5, 6, 6.5, 7, 7.5, 8, 9, 10, 11, 12, 13 mm
-  14 x 1/4" 6-PT Вложки/Sockets/Tubulare : 5/32", 3/16", 7/32", 1/4", 9/32", 5/16", 11/32", 3/8", 13/32", 7/16", 15/32"; 1/2", 17/32", 9/16"
-  3 x 1/4" Вложки/Sockets/Tubulare Torx: E1/4",E5/16",E3/8"



Комплект инструменти 40 часту 1/4" & 3/8" / 40pcs Socket wrench set 1/4" & 3/8" / Set 40 tubulare 1/4" si 3/8"

art.No	size	box	ctn
330516	1/4"&3/8" 4-17mm	-	10

-  1 x 3/8" Тресчотка/Ratchet handle/Surubelnita cu clichet 180mm
-  1 x 1/4" Отвертка за вложки/Spinner handle/Surubelnita ptr tubulare 140mm
-  1 x 3/8" Удължител/Extension bar/Adaptoare lung 65mm
-  1 x Адаптор/ADP/Adaptor 3/8"F-1/4"M
-  1 x 3/8" Вложка за свещи/Spark plug socket/Tubulara ptr bujii: 13/16" (21mm)
-  1 x 3/8" Диск/Disk/Disk
-  12 x 1/4" 6-PT Вложки/Sockets/Tubulare: 4, 4.5, 5, 5.5, 6, 7, 8, 9, 10, 11, 12, 13 mm
-  12 x 1/4" 6-PT Вложки/Sockets/Tubulare: 5/32", 3/16", 7/32",9/32", 5/16", 11/32", 3/8", 13/32", 7/16", 15/32", 1/4", 1/2"
-  3 x 1/4" Вложки/Sockets/Tubulare Torx: E1/4",E5/16",E3/8"
-  6 x 3/8" 6-PT Вложки/Sockets/Tubulare: 14, 16, 17mm; 9/16", 5/8", 1/2"





Комплект инструменти 52 части 1/4" & 1/2" / 52pcs Socket wrench set / Set 52 tubulare



art.№	size	box	ctn
330518	1/4" & 1/2" 4-32mm	-	5

- 2 x Тресчотки/Ratchet handles/Surubelnita cu clichet: 1/4" x 125mm; 1/2" x 225mm;
- 1 x 1/4" Отвертка за крайници/Screwdriver/Surubelnita ptr biti 200mm
- 2 x Върток Т-образен/Sliding "T" bar/Levier strangere satin 1/4" (120mm) & 1/2" (250mm)
- 1 x Подвижна свързка/Universal joint/Adaptor tubulare flexibil
- 1 x 1/4" Вложка за крайници/Bits socket/Tubulara ptr biti
- 1 x 1/4" Адаптор за вложки/ADP for sockets/Adaptor ptr tubulare
- 1 x 1/4" Удължител/Extension bar/Adaptoare lung 75mm
- 2 x 1/2" Удължители/Extension bars/Adaptoare lung : 125mm; 250mm
- 2 x Вложки за свещи/Spark plug sockets/Tubulara ptr bujii: 16mm & 21mm
- 11 x 1/4" Вложки/Sockets/Tubulare: 4, 4.5, 5, 5.5, 6, 7, 8, 9, 10, 11, 13mm
- 13 x 1/2" Вложки/Sockets/Tubulare: 10, 11, 12, 13, 14, 15, 16, 17, 19, 22, 24, 27, 32mm
- 3 x Крайници/Bits/Biti SL: 5, 6, 7mm
- 3 x Крайници/Bits/Biti PH: #1, #2, #3
- 6 x Крайници/Bits/Biti HEX: 3, 4, 5, 6, 6.5, 7mm
- 3 x Шестгори/HEX keys/Cheie imbus: 1.5, 2, 2.5mm

Комплект инструменти 52 части 1/4" & 1/2" мем. кум. / 52pcs Socket wrench set 1/4" & 1/2" metal box / Set 52 tubulare 1/4" si 1/2", cutie metalica



art.№	size	box	ctn
330551	1/4" & 1/2" 4-32mm	-	5

- 2 x Тресчотки/Ratchet handles/Surubelnita cu clichet: 1/4" x 125mm; 1/2" x 210mm;
- 1 x 1/4" Отвертка за крайници/Screwdriver/Surubeln. ptr biti: 160mm
- 2 x Върток Т-образен/Sliding "T" bar/Levier strangere satin 1/4" (120mm) & 1/2" (250mm)
- 1 x 1/4" Вложка за крайници/Bits socket/Tubulara ptr biti
- 1 x 1/4" Адаптор за вложки/ADP for sockets/Adaptor ptr tubulare
- 1 x 1/4" Удължител/Extension bar/Adaptoare lung 75mm
- 2 x 1/2" Удължители/Extension bars/Adaptoare lung : 125mm; 250mm
- 2 x Вложки за свещи/Spark plug sockets/Tubulara ptr bujii: 16mm & 21mm
- 11 x 1/4" Вложки/Sockets/Tubulare: 4, 4.5, 5, 5.5, 6, 7, 8, 9, 10, 11, 13mm
- 13 x 1/2" Вложки/Sockets/Tubulare: 10, 11, 12, 13, 14, 15, 16, 17, 19, 22, 24, 27, 32mm
- 4 x Крайници/Bits/Biti SL: 4, 5, 6, 7mm
- 3 x Крайници/Bits/Biti PH: #1, #2, #3
- 6 x Крайници/Bits/Biti HEX: 3, 4, 5, 6, 7, 8mm
- 3 x Шестгори/HEX keys/Cheie imbus: 1.5, 2, 2.5mm

Комплект инструменти 108 части 1/4" & 1/2" / 108 pcs Socket wrench set 1/4" & 1/2" / Set 108 tubulare 1/4" & 1/2"



art.№	size	box	ctn
341101	1/4" & 1/2" 4-32 mm	1	4







- 2 x Тресчотки/Ratchet handles/Surubelnite cu clichet 1/4" x 145 mm; 1/2" x 250 mm
- 1 x 1/4" Отвертка за вложки/Spinner handle/Surubelnita ptr tubulare 150 mm
- 2 x 1/4" Удължители/Extension bars/Adaptoare lung 50mm & 75 mm
- 2 x 1/2" Удължители/Extension bars/Adaptoare lung 125mm & 250 mm
- 1 x 1/4" Върток Т-образен/Sliding "T" bar/Levier strangere satin 115 mm
- 1 x 1/2" Върток Т-образен/Sliding "T" bar/Levier strangere satin 250 mm
- 2 x Подвижна свързка/Universal joint/Adaptor tubulare flexibil 1/4" & 1/2"
- 13 x 1/4" Вложки/Sockets/Tubulare: 4, 4.5, 5, 5.5, 6, 7, 8, 9, 10, 11, 12, 13, 14 mm
- 8 x 1/4" Дълбоки вложки/Deep sockets/Tubulare profund: 6, 7, 8, 9, 10, 11, 12, 13 mm
- 5 x 1/4" Вложки/Sockets/Tubulare Torx: E4, E5, E6, E7, E8
- 17 x 1/2" Вложки/Sockets/Tubulare: 10, 11, 12, 13, 14, 15, 16, 17, 18, 19, 20, 21, 22, 24, 27, 30, 32 mm
- 5 x 1/2" Дълбоки вложки/Deep sockets/Tubulare profund: 14, 15, 17, 19, 22 mm
- 8 x 1/2" Вложки/Sockets/Tubulare Torx: E10, E11, E12, E14, E15, E18, E20, E22
- 2 x 1/2" Вложки за свещи/Spark plug sockets/Tubulara ptr bujii: 16 mm & 21 mm
- 1 x Адаптор за крайници/ADP for bits/Adaptor ptr biti 1/2"-5/16"
- 17 x 5/16" Крайници/Bits/Biti: SL8, 10, 12mm; PH#3, #4; Torx T40, 45, 50, 55, 60; PZ3, 4; HEX7, 8, 10, 12, 14 mm
- 18 x 1/4" Вложки с крайници/Bit Sockets/Bit Tubulare: SL4, 5.5, 6.5 mm; PH#1, #2; PZ1, 2; HEX H3, 4, 5, 6; Torx T8, 10, 15, 20, 25, 27, 30;
- 3 x Шестгори/HEX keys/Cheie imbus: 1.5, 2, 2.5 mm



Комплект инструменти 24 части 1/2" / 24pcs Socket wrench set 1/2" / Set 24 tubulare 1/2"



art.№	size	box	ctn
330521	1/2" 8-30mm	-	5

-  • 1 x 1/2" Тресчотка/Ratchet handle/Surubelnita cu clichet 250 mm
-  • 1 x 1/2" Върток Т-образен/Sliding "T" bar/Levier strangere satin: 250 mm
-  • 1 x Върток за бързо въртене/Speeder handle/Maner ptr tubulare: 420 mm
-  • 2 x 1/2" Удължителни/Extension bars/Adaptoare lung: 125 mm; 250 mm
-  • 1 x Вложка за свещи/Spark plug socket/Tubulara ptr bujii: 13/16" (21 mm)
-  • 18 x Вложки/Sockets/Tubulare: 8, 10, 11, 12, 13, 14, 15, 16, 17, 18, 19, 20, 21, 22, 23, 24, 27, 30 mm

Клеци чирак с метална гръжка/ Locking pliers self grip, metal handle / Cleste autoblocant

art.№	size	box	ctn
213107	250mm	15	60

- Закалени челюсти
- Лост за бързо освобождаване
- Регулиращ болт за силата на захвата
- Hardened jaws for on-the-job toughness
- Quick release lever
- Adjustable screw for pressing force
- Eliberare rapidă
- Falci calite



Клеци зегер, к-м 4 броя / Snap ring pliers, 4pcs set / Set 4 clesti sigurante

art.№	size	box	ctn
219903	150mm	25	100

- Дръжки с пластмасово покритие
- 2 x зегери-универсални (отварящи/затварящи) - прави
- 1 x зегери-универсални (отварящи/затварящи) - извити 45°
- 1 x зегери-универсални (отварящи/затварящи) - извити 90°
- Plastic covered handles
- 2 x seegers universal (opening/closing) - straight
- 1 x seegers universal (opening/closing) - bent nose 45°
- 1 x seegers universal (opening/closing) - bent nose 90°



Клеци замба / Revolving punch pliers / Cleste producea

art.№	size	box	ctn
214920	200mm	30	60

- Размер замби / Drift sizes / Dimensiuni: 2, 2.5, 3, 3.5, 4, 4.5mm



Замби комплект 5 бр. / Hollow punch pins, 5 pcs set / Set 5 producele

art.№	size	box	ctn
499908		12	144

- Размер / Sizes / Dimensiuni: 2, 3, 4, 6, 8mm



Замби комплект 12 бр. / Hollow punch pins, 12 pcs set / Set 12 producele

art.№	size	box	ctn
499909		5	20

- Размер / Sizes / Dimensiuni: 1/8"; 5/32"; 3/16"; 7/32"; 1/4"; 5/16"; 3/8"; 7/16"; 1/2"; 9/16"; 5/8"; 3/4"





Чук с дървена гръжка / Hammer with wooden handle / Ciocan cu coada din lemn



art.№	size	box	ctn
240318	100g	12	60
240319	200g	6	60
240311	300g	6	60
240312	500g	6	36
240320	800g	6	24
240313	1000g	6	24
240314	1500g	6	12
240315	2000g	6	12

- Глава от закалена стомана
- Удобна дървена гръжка
- Head of hardened steel
- Comfortable wooden handle
- Cap din otel calit
- Coada ergonomica din lemn

Чук гүмен с обла дървена гръжка, черен / Black rubber mallet, round wooden handle / Ciocan cauciuc negru, maner lemn rotund



art.№	size	box	ctn
241163	225g	-	80
241164	340g	-	60
241165	445g	-	50
241167	900g	-	24

- Глава от високоеластичен каучук
- Rubber head
- Cap din cauciuc

Чук гүмен с метална гръжка, черен / Black rubber mallet, metal handle / Ciocan cauciuc negru, maner metal



art.№	size	box	ctn
240902	340g	-	50
240901	445g	-	50

- Глава от високоеластичен каучук
- Метална гръжка с гүмено покритие в основата
- Rubber head
- Metal handle with rubber cover
- Cap din cauciuc
- Coada ergonomica din metal



Брадва с дървена гръжка / Axes with wooden handle / Topor coada lemn

art.№	size	box	ctn
381325	400g	-	24
381359	500g	-	24
381326	600g	6	24
381327	800g	6	24
381328	1000g	6	24
381329	1250g	-	12
381330	1500g	-	12
381331	1800g	-	12
381332	2000g	-	12

- Глава от закалена стомана
- Удобна дървена дръжка
- Head of hardened steel
- Comfortable wooden handle
- Cap din otel calit
- Coada ergonomica din lemn



Тесла с дървена гръжка / Adze with wooden handle / Tesla coada lemn

art.№	size	box	ctn
381358	450mm / 500g	6	36

- Глава от закалена стомана
- Удобна дървена дръжка
- Head of hardened steel
- Comfortable wooden handle
- Cap din otel calit
- Coada ergonomica din lemn



Трион за гръво / Hand saw / Fierastrau

art.№	size	box	ctn
371731	400mm	-	60
371732	450mm	-	60
371733	500mm	-	60

- Острие от висококачествена закалена стомана
- Двустранно заточени зъби
- Ергономична дръжка за удобен захват
- Saw blade of high quality steel
- Hardened teeth for long lasting sharpness
- Ergonomic comfort grip handle
- Lama de taire fabricata din otel inalt aliat
- Dinti caliti pentru o durata de utilizare mai mare
- Maner ergonomic



Трион насвател / Mitre box / Ferestrua trasare la unghi

art.№	size	box	ctn
371713	250mm	1	36

- Острие от висококачествена закалена стомана
- Двустранно заточени зъби
- Ергономична дръжка за удобен захват
- Saw blade of high quality steel
- Hardened teeth for long lasting sharpness
- Ergonomic comfort grip handle
- Lama de taire fabricata din otel inalt aliat
- Dinti caliti pentru o durata de utilizare mai mare
- Maner ergonomic





Бичкия / Garden bow saw / Ferestrau coarba



art.№	size	box	ctn
371301	525mm	6	24
371302	600mm	6	24
371303	750mm	6	24
371304	900mm	6	24

- Двустранно заточени зъби
- Лостов фиксатор за острието
- Hardened teeth for long lasting sharpness
- Fixation lever for the blade
- Dinti caliti pentru o durata de utilizare mai mare
- Surub de fixare pentru lama

Ножовка за метал / Hacksaw frame / Bomfaier



art.№	size	box	ctn
371103	300mm	12	48

Ножовка за метал, пластм. гръжка / Hacksaw frame, plastic handle / Bomfaier-maner plastic



art.№	size	box	ctn
371108	300mm	-	60

- Двустранно заточени зъби
- Ергономична пластмасова дръжка за удобен захват
- Винтов фиксатор на острието
- Hardened teeth for long lasting sharpness
- Ergonomic plastic handle for comfortable grip
- Fixation screw for the blade
- Dinti caliti pentru o durata de utilizare mai mare
- Maner ergonomic din plastic
- Surub de fixare pentru lama

Лист за ножовка, к-м 6 бр. / 6 pcs/ set Hacksaw blade / Set 6pcs panze



art.№	size	box	ctn
371117	300mm	-	240

- Двустранно заточени, закалени зъби
- Hardened teeth for long lasting sharpness, 2 way sharpened
- Dinti caliti pentru o durata de utilizare mai mare

Лист за ножовка двоен, кум. 72бр. / 72 pcs/set double eded Hacksaw blade / Set 72pcs panze



art.№	size	box	ctn
371102	300mm	-	10

- Двустранно заточени, закалени зъби
- Hardened teeth for long lasting sharpness, 2 way sharpened
- Dinti caliti pentru o durata de utilizare mai mare



Флашки и метчици, k-m 20 бр. / Tap & die, 20pcs set / Set filiere cu suport, 20 piese

art.№	size	box	ctn
490906	-	-	20

- Флашки и метчици размер: M3x0.5; 4x0.7, 5x0.8; 6x1.0; 7x1.0; 8x1.25; 10x1.5; 12x1.75; 1/8NPT27
- 1 x върток за флашки, 1 x върток за метчици
- Кутия с плъзгащ се капак
- Containing one tap and die in each of the following sizes: M3x0.5; 4x0.7, 5x0.8; 6x1.0; 7x1.0; 8x1.25; 10x1.5; 12x1.75; 1/8NPT27;
- 1 x adjustable Tap wrench; 1 x adjustable Die handle, Box with sliding cap
- Contine tarozi si filiere ,cate 1 buc, urmatoarele dimensiuni: M3x0.5; 4x0.7, 5x0.8; 6x1.0; 7x1.0; 8x1.25; 10x1.5; 12x1.75; 1/8NPT27;
- 1 x cheie ajustabila pentru tarozi
- 1 x cheie ajustabila pentru filiere



Флашки и метчици, k-m 40 бр. / Tap & die, 40pcs set / Set filiere cu suport, 40 piese

art.№	size	box	ctn
490907	-	-	20

- Флашки и метчици размер: M3x0.5; 3x0.6; 4x0.7; 4x0.75; 5x0.8; 5x0.9; 6x0.75; 6x1.0; 7x0.75; 7x1.0; 8x1.0; 8x1.25; 10x1.25; 10x1.5; 12x1.5; 12x1.75; 1/8NPT27
- 1 x върток за флашки; 1 x върток за метчици
- 1 x Т-образен върток за метчици
- 1 x Отвертка;
- 1 x Резбомер;
- Contain one tap & die in each of the following sizes:
- M3x0.5; 3x0.6; 4x0.7; 4x0.75; 5x0.8; 5x0.9; 6x0.75; 6x1.0; 7x0.75; 7x1.0; 8x1.0; 8x1.25; 10x1.25; 10x1.5; 12x1.5; 12x1.75; 1/8NPT27
- 1 x adjustable Tap wrench;
- 1 x "T" handle Tap wrench;
- 1 x adjustable Die handle; 1 x Screwdriver
- 1 x Srew pitch gauge;



Пилу ключарски, гуамант, k-m 10 бр./ Diamand needle files, 10pcs set / Set 10 pile diamantate

art.№	size	box	ctn
361703	50mm	10	200



Нож макетен, пластмасов / Utility knife, plastic / Cutter multifunctional

art.№	size	box	ctn
370143	18x155mm	12	720





Нож макетен / Utility knife / Cutter multifunctional

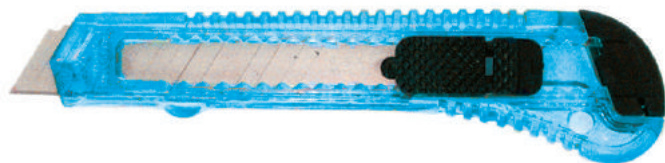

art.№	size	box	ctn
370103	18x155mm	150	600

- Прецизно заточен, 7-сегментен резец
- Заклучващ механизъм
- Precision sharpened cutter, 7 snap-off elements
- Safety lock
- Lama cu 7 segmente de rupere
- Blocaj de siguranta

Нож макетен, метална глава / Utility knife, metal head / Cutter multifunctional



art.№	size	box	ctn
370104	18x165mm	48	480

- Стоманен водач на резеца
- Заклучващ механизъм
- Прецизно заточен, 15-сегментен резец
- Blade guide made of stainless steel
- Safety lock
- Precision sharpened cutter, 15 snap-off elements
- Ghidaj lama fabricat din otel inox
- Blocaj de siguranta
- Lama cu 7 segmente de rupere

Нож макетен, к-м 8бр. / Utility knife, 8pcs set / 8pcs/set cuttere diverse



art.№	size	box	ctn
370112		30	120

Стъргалка за стикери / Scraper for stickers / Razuior pentru etichete autoadezive

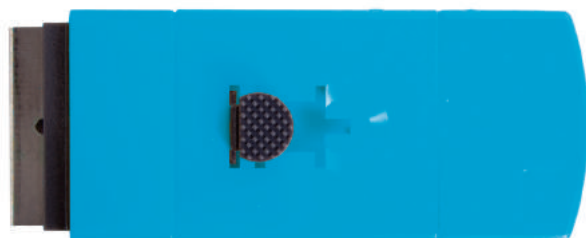

art.№	size	box	ctn
371107	40 mm	48	576

- Ширина на острието: 40 mm
- Лесна смяна на острието
- Материал на тялото: пластмаса
- Пространство за резервни остриета
- Blade width: 40 mm
- Easy replacement of the blade
- Body material: plastic
- Holder for spare blades
- Lama cu 7 segmente de rupere
- Latime lama: 40 mm
- Inlocuire usoara a lamei
- Material: plastic
- Magazie pentru lame de rezerva



Ножици за ламарина, дясно рязане / Tin snips, right cut / Foarfeca tabla cu taiere pe dreapta

art.№	size	box	ctn
370708	250mm	6	60

- Изработена от висококачествена, закалена, въглеродна стомана
- Ергономична дръжка за удобен захват
- Ласно заключване с една ръка
- Made by high quality, hardened steel
- Ergonomic handle for comfortable grip
- Easy lock with one hand
- Fabricat din oțel înalt aliat
- Maner ergonomic pentru o prindere mai bună
- Blocare rapidă cu o singură mână



Ножици за ламарина, права / Tin snips, straight / Foarfeca tabla

art.№	size	box	ctn
370709	250mm	10	60

- Изработена от висококачествена, закалена, въглеродна стомана
- Ергономична дръжка за удобен захват
- Ласно заключване с една ръка
- Made by high quality, hardened steel
- Ergonomic handle for comfortable grip
- Easy lock with one hand
- Fabricat din oțel înalt aliat
- Maner ergonomic pentru o prindere mai bună
- Blocare rapidă cu o singură mână

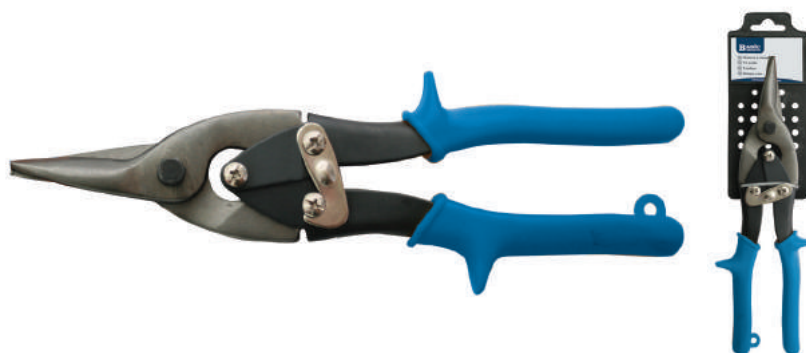

Ножици за ламарина, ляво рязане / Tin snips, left cut / Foarfeca tabla cu taiere pe stanga

art.№	size	box	ctn
370710	250mm	6	60

- Изработена от висококачествена, закалена, въглеродна стомана
- Ергономична дръжка за удобен захват
- Ласно заключване с една ръка
- Made by high quality, hardened steel
- Ergonomic handle for comfortable grip
- Easy lock with one hand
- Fabricat din oțel înalt aliat
- Maner ergonomic pentru o prindere mai bună
- Blocare rapidă cu o singură mână

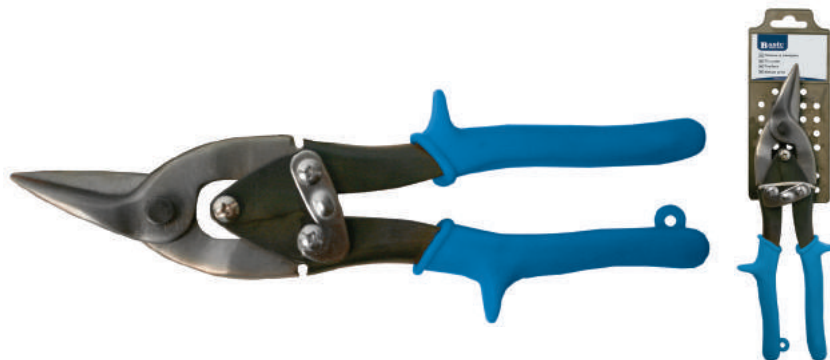

Ножици за ламарина-гилотина / Tile cutter / Ghilotina de banc

art.№	size	box	ctn
370707	250mm	-	4

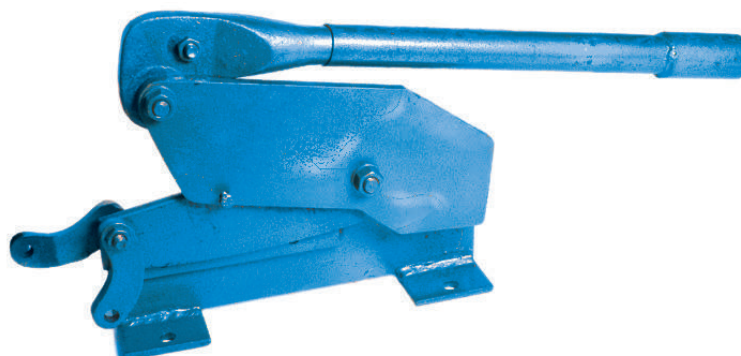



Ножица за PVC тръби / PVC pipe cutter / Foarfeca taiat tevi PVC



art.№	size	box	ctn
290303	42mm	12	48

- Метално тяло
- Прецизно заострен нож от неръждаема стомана
- Metal body
- Stainless steel knife
- Corp metalic
- Cutit din otel inox

Ножица лозарска с резервно острие / Pruning shear with spare blade / Foarfeca ptr. vie cu lama de rezerva



art.№	size	box	ctn
382503	8"/200mm	6	60

- Резервно острие - 1бр.
- Ергономични дръжки с пластмасово покритие
- Заключващ механизъм
- Additional blade - 1pc
- Ergonomic handles, plastic covered
- Locking mechanism
- Lama de rezerva - 1 buc
- Manare ergonomice, acoperite cu platic
- Mecanism de blocare

Ножица за храсти с метална гръбжка / Hedge shear / Foarfeca gard viu



art. N	Length	box	ctn
382902	500mm	-	24

- С вълнообразно острие
- Възможност за регулиране на острието
- With a wavy blade
- Adjustable
- Cu o lamă de ondulat
- Reglabil

Винторезка, к-т 4 глави / 4 pcs/set Ratchet die stocks / Set filiere tevi cu clichet 4 piese



art.№	size	box	ctn
290102	1/2" - 1" 1/4"	-	4

- Размер на главите / Sizes / Dimensiuni:
- 1/2", 3/4", 1", 1_1/4"

Глава за винторезка / Head ratchet die stocks machine / Filiera tevi

art.№	size	box	ctn
290104	1/2"	1	20



Стяга гърводелска / F-clamp, wooden handle / Presa manuala

art.№	size	box	ctn
250101	50x150mm	-	50
250102	50x200mm	-	50
250103	50x250mm	-	50
250104	50x300mm	-	50
250105	80x150mm	-	25
250106	80x200mm	-	25
250107	80x250mm	-	25
250108	80x300mm	-	25
250109	80x400mm	-	25
250111	120x300mm	-	10
250112	120x400mm	-	10
250113	120x500mm	-	10
250114	120x600mm	-	10
250115	120x800mm	-	10
250116	120x1000mm	-	10



Ролетка пластмасова с двоен стоп / Measuring tape ABS case, two stops / Ruleta carcasa ABS, dublu-stop

art.№	size	box	ctn
260311	2m x 13mm	12	240
260312	3m x 16mm	12	180
260313	5m x 19mm	12	120
260314	5m x 25mm	12	120
260315	7,5m x 25mm	12	60

- Материал на тялото: пластмаса, двуцветна
- Двоен стоп
- Body material: two-colored ABS
- Double lock system
- Material carcasa: Plastic ABS in doua culori



Ролетка фибростъкло / Measuring tape rule, fiberglass / Ruleta fibra de sticla

art.№	size	box	ctn
261308	20m	1	60
261309	30m	1	60

- Материал на тялото - пластмаса
- Материал на лентата - фибростаъкло
- Метален крайник на лентата, с халка
- Удобна гумена дръжка
- Прибиращ се лост за бързо пренавиване
- Body material - ABS
- Material of measuring tape - fiberglass
- Metal tip of the measuring tape, with ring
- Comfortable rubber hand holder
- Material carcasa: Plastic ABS
- Material banda-fibra de sticla
- Carlig cu inel metalic la capatul benzii
- Maner cauciucat





Ролетка пластмасова, гъла / Measuring tape rule, plastic / Ruleta

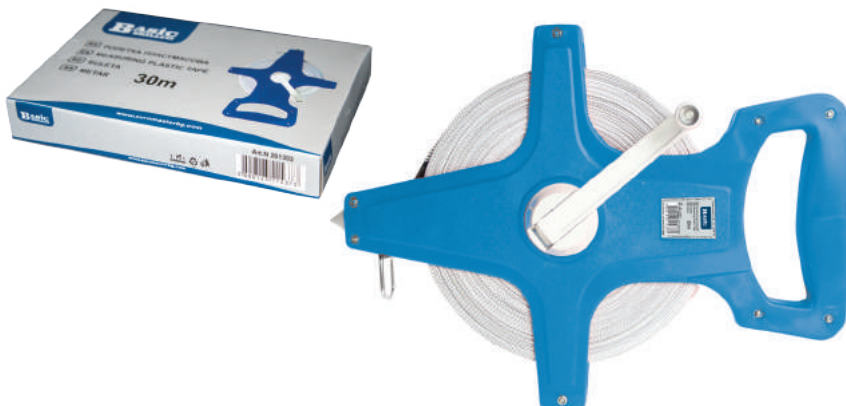

art.№	size	box	ctn
261303	30m	1	24
261304	50m	1	24

- Материал на тялото - пластмаса
- Пластмасов накрайник на лентата, с халка
- Центриращ връх на тялото
- Заклучващ се лост за бързо пренавиване
- Body material - ABS
- Plastic tip of the measuring tape, with ring
- Centering tip of the body
- Locking lever for retracting
- Material carcasa: Plastic ABS
- Carlig cu inel din plastic la capatul benzii
- Maner blocabil pentru rebobinare

Нивелур с магнит / Level magnetic / Nivela galbena



art.№	size	box	ctn
279903	225mm	-	100

- Материал на тялото- пластмаса
- 3 либели
- Body material- ABS
- 3 vials
- Material carcasa: Plastic ABS
- 3 bule

Ъгъл прав / Try Square / Echer



art.№	size	box	ctn
289902	250mm	12	120
289903	300mm	12	120
289904	350mm	12	120
289905	400mm	12	120
289913	500mm	12	120

- Стоманена лента
- Алуминиева пета
- 4-странна измервателна скала
- Steel band; Alluminum handle
- 4-sided measuring scale
- Banda de otel
- Maner de aluminiu
- Scala de masurare marcata pe patru parti

Щанга 500mm / Tire lever 500mm / Levier roti 500mm



art.№	size	box	ctn
332219	500mm	-	20

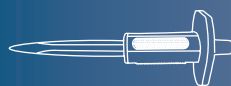

Длемо остро с предпазител / Mason chisel, pointed head with hand guard / Dalta ascutita cu protectie

art.№	size	box	ctn
329903	Ø14x250mm	12	48



Длемо секач с предпазител / Mason chisel, flat head with hand guard / Dalta plata cu protectie

art.№	size	box	ctn
329906	14x250mm	12	48

- Ширина на резеца: 17mm
- Cutter width: 17mm
- Latime de taiere: 17mm



Длемо остро / Mason chisel, pointed head / Dalta ascutita

art.№	size	box	ctn
329904	Ø16x300mm	6	24



Длемо секач / Mason chisel, flat head / Dalta plata

art.№	size	box	ctn
329907	16x300mm	6	24

- Ширина на резеца: 24mm
- Cutter width: 24mm
- Latime de taiere: 24mm





Нитачка с нитове 40 бр., в блистер / Hand riveter with 40 pop rivets, blister / Cleste pop nituri cu 40 nituri, blister



art.№	size	box	ctn
491153	250mm	12	24

- Глава от висококачествена стомана
- 4бр. накрайници и ключ, закрепен към тялото на нитачката
- Удобни пластмасови дръжки
- Head from high quality steel
- 4pcs nozzles and key attached to the body
- Comfortable plastic handles
- Cap fabricat din otel inalt aliat
- 4 capete de nituire si cheie fixate pe corpul pistolului
- Manere din plastic confortabile

Вакуум за стъкла / Suction lifter, plastic / Ventuza transport geamuri - plastic



art.№	size	box	ctn
499905	-	1	60

- Пластмасово тяло
- Plastic body
- Material: Plastic

Вакуум за стъкла, двоен / Suction lifter, double, plastic / Ventuza transport geamuri dubla-plastic

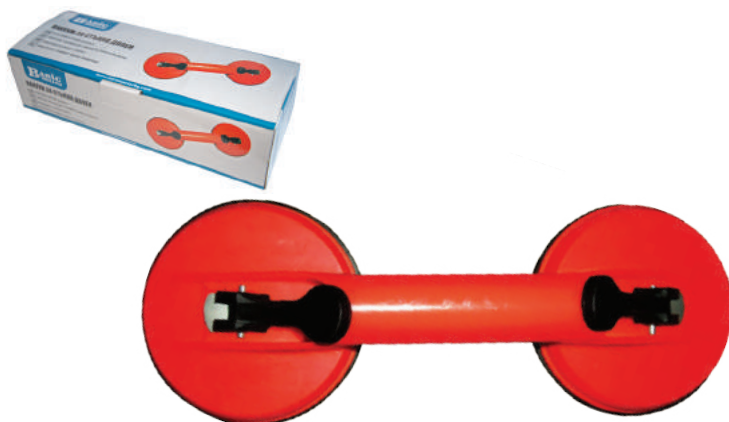

art.№	size	box	ctn
499906	-	1	20

- Пластмасово тяло
- Plastic body
- Material: Plastic

Вакуум за стъкла, троен / Suction lifter, triple, plastic / Ventuza transport geamuri tripla-plastic



art.№	size	box	ctn
393301	-	1	12

- Пластмасово тяло
- Plastic body
- Material: Plastic



Четка телена, пластм. г-ка, 3 пeгa / Steel wire brush, plastic handle, 3 rows / Perie sarma, maner plastic 3 randuri

art.№	size	box	ctn
340508	-	12	120



Четка телена, пластм. г-ка, 4 пeгa / Steel wire brush, plastic handle, 4 rows / Perie sarma, maner plastic, 4 randuri

art.№	size	box	ctn
340509	-	12	120



Четка телена, 5 пeгa, месинг / Brass wire brush, 5 rows / Perie sarma, maner lemn, 5 randuri

art.№	size	box	ctn
340501	-	30	240

- Дървена дръжка
- Wooden handle
- Maner de lemn



Четка телена, 5 пeгa / Steel wire brush, 5 rows / Perie sarma maner lemn, 5 randuri

art.№	size	box	ctn
340502	-	12	120

- Дървена дръжка
- Wooden handle
- Maner de lemn





Колан за инструменти / Carpenter's leather apron / Centura port-scule piele



art.№	size	box	ctn
499912	-	-	50

- Материал: кожа
- 11 джоба
- Material; split leather
- 11 pockets
- Material; Piele
- 11 buzunare

Помпа крачна / Foot air pump, single tube / Pompa picior simpla



art.№	size	box	ctn
332101	950cm ³	1	25

- Манометър
- 2 допълнителни накрайника
- Manometer
- 2 additional nozzles
- Manometru
- 2 duze aditionale

Помпа крачна, двойна / Foot air pump, double tube / Pompa picior dubla



art.№	size	box	ctn
332102	1900cm ³	1	15

- Манометър
- 2 допълнителни накрайника
- Manometer
- 2 additional nozzles
- Manometru
- 2 duze aditionale

Ключ за велосипед / Wire cable lock / Lacat + lant

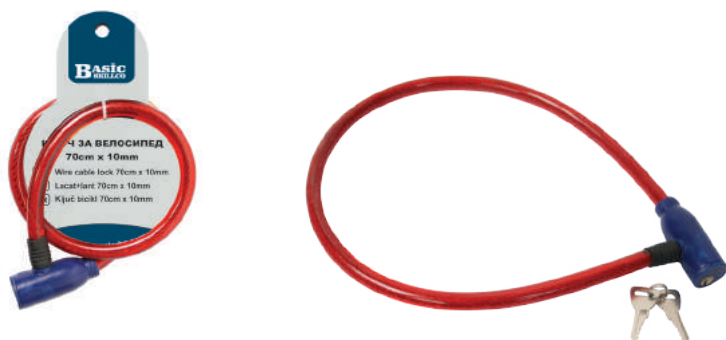

art.№	size	box	ctn
509905	70cm x 10mm	50	100

- Дължина на веригата: 70cm
- Дебелина на веригата: Ø10
- 2 ключа
- Length of the chain: 70cm
- Thickness of the chain: Ø10
- 2 keys
- Lungimea lantului: 70cm
- Grosime zala: Ø10
- 2 chei

Верига за врата с резе / Door guard / Zavor usa cu lant siguranta

art.№	size	box	ctn
530502	200mm	24	96



Връзки кабелни, к-м 100 бр. / Nylon tails, 100 pcs set / Set 100 coliere plastic

art. №	size	pcs in bag	ctn
729915	2.5x150mm	100	400
729916	2.5x200mm	100	250
729702	2.8x250mm	100	220
729701	3.6x250mm	100	200
729917	3.6x300mm	100	100
729706	3.6x370mm	100	125

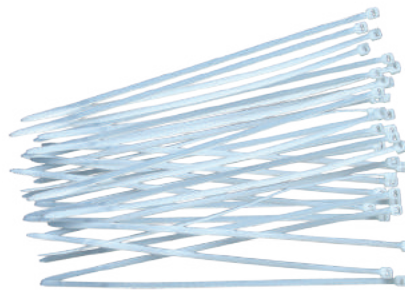

Молив гърбоводелски / Carpenter pencils / Creioane tamplarie

art.№	size	box	ctn
549919	-	72	1440



О-пръстени, комплект 50 броя / O-ring assortment, 50pcs set / Set 50 garnituri

art.№	size	box	ctn
540717	-	-	300



Скоби за водни съединения, к-м 10бр. / Hose clamp, 10pcs set / Set 10 coliere metalice

art.№	size	box	ctn
829906	-	40	240

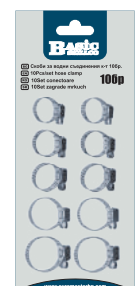

topStrong



Лансирана на пазара през 2006 г., **TopStrong** непрестанно се утвърждава като символ на постигнатата хармония и баланс между качество и практична цена на гама хоби инструменти за боядисване и декорация, за зидаро-мазачни дейности, крепежни елементи и обща железария.

В гамата на TopStrong се включват и изключително удобните и практични предпазни средства, работно облекло, обувки и дъждобрани – всички с високо качество и в пълно съответствие с изискванията на Европейските норми и директиви.

Launched on the market in 2006, **TopStrong** is a proven symbol of achieved harmony and balance between quality and practical price of hobby tools for painting, decoration, masonry, fasteners and hardware.

In the product range of TopStrong are included also comfortable and practical protective equipment, clothing, shoes and raincoats - all with high quality and in full compliance with the requirements of European Directives and Regulations.

Lansata pe piata in anul 2006, gama **TopStrong**, dovedeste ca echilibrul dintre calitate si pretul practic al uneltelor hobby pentru vopsit si decoratiuni, zidarie, si elemente de fixare, este simbolul succesului.

In gama de produse TopStrong sunt incluse si echipamente de protectie, imbracaminte, pantofi de lucru si impermeabile, extrem de confortabile si practice. Toate acestea sunt de inalta calitate si conform Directivelor si Regulamentelor Europene.



Валяк полиамуг, нишка 18 mm / Roller polyamide, pile 18 mm / Rola trafalet poliamida 18 mm

art. N	size(L,Ø1,Ø2)	pile	box	ctn
540656	180x54x6 mm	18mm	-	120
540657	230x54x6 mm	18mm	-	120
540658	250x54x6 mm	18mm	-	48

- Изработен от висококачествени полиамидни влакна с дължина 18mm.
- Приложение: За нанасяне на алкидни и полиуретанови бои, лакове, грундове, емайл лакове, различни видове смоли и битуми, върху средно неравни и груби повърхности.
- Made from high quality polyamide pile 18mm.
- Application: For polyurethane and alkid paints, varnish, primers, enamel paints, different type of resins and bitumens on medium rough and rouhg surfaces.
- Fabricat din poliamidă de inalta calitate, cu lungimea firului de 18 mm.
- Aplicații: Pentru vopseluri poliuretanicе si alchidice, lacuri, grunduri, vopsele emailuri, diverse tipuri de rășini și bitumuri pe suprafețe neregulate.

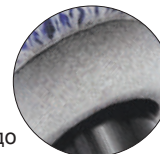

* с подложка, благодарение на която боята се разнася и до най-труднодостъпните места

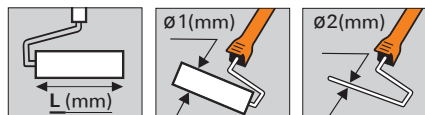

Валяк полиамуг, нишка 12 mm / Roller polyamide, pile 12 mm / Rola trafalet poliamida 12 mm

art. N	size(L,Ø1,Ø2)	pile	box	ctn
540648	180x50x6 mm	12mm	-	100
540649	230x50x6 mm	12mm	-	100
540655	250x50x6 mm	12mm	-	48

- Изработен от висококачествени полиамидни влакна с дължина 12mm.
- Приложение: За нанасяне на алкидни и полиуретанови бои, лакове, грундове, емайл лакове, различни видове смоли и битуми, върху средно неравни и груби повърхности.
- Made from high quality polyamide pile 12mm.
- Application: For polyurethane and alkid paints, varnish, primers, enamel paints, different type of resins and bitumens on medium rough and rouhg surfaces.
- Fabricat din poliamidă de inalta calitate, cu lungimea firului de 12mm.
- Aplicații: Pentru vopseluri poliuretanicе si alchidice, lacuri, grunduri, vopsele emailuri, diverse tipuri de rășini și bitumuri pe suprafețe neregulate.



* с подложка, благодарение на която боята се разнася и до най-труднодостъпните места

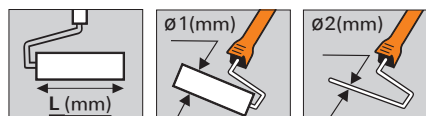

Валяк Велур, нишка 4 mm / Roller 50% wool, pile 4 mm / Rola trafalet 50% Lama

art. N	size(L,Ø1,Ø2)	pile	box	ctn
540690	180x44x6 mm	4mm	-	100

- Изработен от фини вълнени влакна с дължина 4mm и голяма гъстота.
- Приложение: За нанасяне на емайл и лакове върху гладки повърхности като осигурява гладък завършващ слой.
- Made of fine wool fiber pile, length 4 mm with high density.
- Application: For paints and varnishes on smooth surfaces ensuring smoothly finished surface.
- Fabricat din fibre de lana, cu lungimea firului de 4mm si densitate mare.
- Aplicații: Pentru, vopsele si emailuri, pe suprafețe netede, asigurand o suprafata finisata.

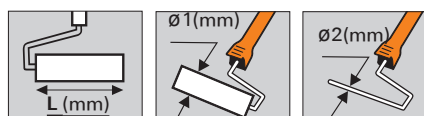



Валяк полиамид + гръжка / Roller polyamide + handle / Rola trafalet poliamida + maner

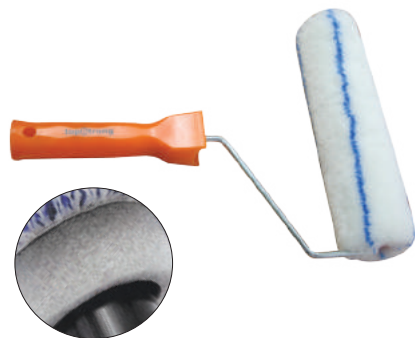

* с подложка, благодарение на която боята се разнася и до най-труднодостъпните места

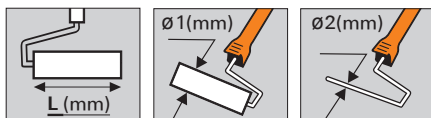

art. N	size(L,Ø1,Ø2)	pile	box	ctn
540698	180x54x6 mm	18mm	-	50
540654	230x54x6 mm	18mm	-	50

- Валяк изработен от висококачествени полиамидни влакна с дължина 18mm.
- Приложение: За нанасяне на алкидни и полиуретанови бои, лакове, грундове, емайл лакове върху средно неравни и гладки повърхности.
- Удобна пластмасова дръжка 300mm.
- Roller made from high quality polyamide pile 18mm.
- Application: For polyurethane and alkyd paints, varnish, primers, enamel paints, different type resins and bitumens on medium rough and rough surfaces.
- Comfortable plastic handle 300mm
- Rola fabricat din poliamidă de inalta calitate, cu lungimea firului de 18mm.
- Aplicatii: Pentru vopseluri poliuretanicе si alchidice, lacuri, grunduri, vopsele emailuri, diverse tipuri de rășini și bitumuri pe suprafețe neregulate.
- Manere din plastic confortabile 300mm

Валяк полиамид + гръжка / Roller polyamide + handle / Rola trafalet poliamida + maner



* с подложка, благодарение на която боята се разнася и до най-труднодостъпните места

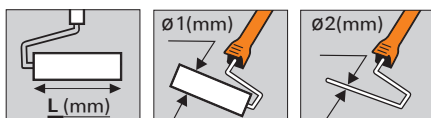

art. N	size(L,Ø1,Ø2)	pile	box	ctn
540697	180x50x6 mm	12mm	-	50
540653	230x50x6 mm	12mm	-	50

- Валяк изработен от висококачествени полиамидни влакна с дължина 12mm.
- Приложение: За нанасяне на алкидни и полиуретанови бои, лакове, грундове, емайл лакове върху средно неравни и гладки повърхности.
- Удобна пластмасова дръжка 300mm
- Roller made from high quality polyamide pile 12mm.
- Application: For polyurethane and alkyd paints, varnish, primers, enamel paints, different type resins and bitumens on medium rough and rough surfaces.
- Comfortable plastic handle 300mm
- Rola fabricat din poliamidă de inalta calitate, cu lungimea firului de 12mm.
- Aplicatii: Pentru vopseluri poliuretanicе si alchidice, lacuri, grunduri, vopsele emailuri, diverse tipuri de rășini și bitumuri pe suprafețe neregulate.
- Manere din plastic confortabile 300mm

Валяк мини заоблени, стек 10 бр./ Flocked foam mini roller, 10 pcs/set / Rola burete, 10 buc

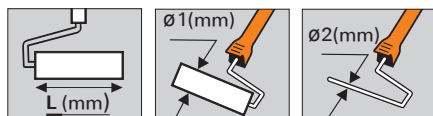

art. N	size(L,Ø1,Ø2)	pile	box	ctn
540645	50x34x6 mm	-	-	72
540646	75x34x6 mm	-	-	72

- Изработен от висококачествен дунапен с висока плътност, електростатично покрит с фини влакна.
- Приложение: За нанасяне на алкидни и полиуретанови бои, високогланцови бои и лакове върху гладки, труднодостъпни повърхности. Осигурява гладък завършващ слой.
- Made from high quality high density foam, covered with fine electrostatic fibers.
- Application: For alkyd and polyurethane paints, high polished paints and varnish on smooth, hardly accessible surfaces. Ensures smooth final surface.
- Fabricat din spuma poliuretanicа de inalta calitate si densitate, acoperita cu fibre fine pentru o mai buna incarcare electrostatica.
- Aplicatii: Pentru vopseluri poliuretanicе si alchidice, lacuri, vopseluri cu grad de finisare mare, pe suprafețe netede și greu accesibile.



Валяк гунапрен екстра, кутия 10 бр./ High density foam mini roller, 10 pcs/set / Role burete, 10 buc

art. N	size(L,Ø1,Ø2)	pile	box	ctn
540643	100x35x6 mm	-	-	96

- Приложение: За нанасяне на вододисперсионни бои върху гладки повърхности. Не се препоръчва използването на алкидни бои и лакове.
- Application: For emulsion paints on smooth surfaces. Not to be used for alkyd paints.
- Aplicatii: Pentru vopseluri tip emulsie cu grad de finisare mare, pe suprafețe netede. A nu se folosi pentru vopseluri alchidice.

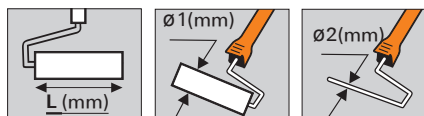

Валяк мини Велур, кутия 10 бр. / 50% Wool mini roller, 10 pcs/set / Rola plush, 10 buc

art. N	size(L,Ø1,Ø2)	pile	box	ctn
540641	100x25x6 mm	-	-	50
540642	150x25x6 mm	-	-	125

- Изработен от фини вълнени влакна. Приложение: За нанасяне на емайли и лакове върху гладки повърхности като осигурява гладък завършващ слой.
- Made of fine wool fiber pile.
- Application: For paints and varnishes on smooth surfaces ensuring smoothly finished surface.
- Fabricat din fibre de lana.
- Aplicatii: Pentru vopsele si emailuri, pe suprafețe netede, asigurand o suprafata finisata.



Валяк мини полиакрил, кутия 10 бр. / Mini roller, acrylic 10 pcs/set / Rola acril, 10 buc

art. N	size(L,Ø1,Ø2)	pile	box	ctn
540639	100x36x6 mm	-	-	125
540640	150x36x6 mm	-	-	60

- Изработен от висококачествени полиакрилни влакна с дължина 12 mm.
- Приложение: За нанасяне на алкидни и полиуретанови бои, лакове, грундове, емайл лакове, различни видове смоли и битуми върху средно неравни и груби повърхности.
- Made from highquality polyacrylic pile, length 12mm.
- Application: For polyurethane and alkyd paints, varnish, primers, enamel paints, different type of resins and bitumens on medium rough and rough surfaces.
- Fabricat din poliacrilic de inalta calitate, cu lungimea firului de 12 mm.
- Aplicatii: Pentru vopseluri poliuretanicе si alchidice, lacuri, grunduri, vopsele emailuri, diverse tipuri de rășini și bitumuri pe suprafețe neregulate.

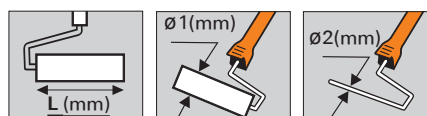



К-т Вана, гръжка и 2 броя Валяци / Set Rollers 2pcs, handle and tray / Set trafalet

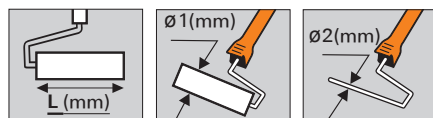

art. N	size(L,Ø1,Ø2)	pile	box	ctn
540650	100x36x6 mm	12 mm	-	24

- Валяк изработен от висококачествени полиакрилни влакна с дължина 12 mm.
- Приложение: За нанасяне на алкидни и полиуретанови бои, лакове, грундове, емайл лакове върху средно неравни и гладки повърхности.
- Ергономична пластмасова дръжка 270 mm.
- Roller made from high quality polyacrylic pile 12 mm.
- Application: For polyurethane and alkid paints, varnish, primers, enamel paints, different type resins and bitumens on medium rough and rouhg surfaces.
- Ergonomic plastic handle 270 mm
- Rola fabricat din poliacriliic de inalta calitate, cu lungimea firului de 12 mm.
- Aplicatii: Pentru vopseluri poliuretanicе si alchidice, lacuri, grunduri, vopsele emailuri, diverse tipuri de rășini și bitumuri pe suprafețe neregulate.

К-т Вана, гръжка и 2 броя Валяци / Set Rollers 2 pcs, handle and tray / Set trafalet

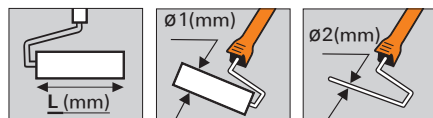

art. N	size(L,Ø1,Ø2)	pile	box	ctn
540651	180x44x6 mm	12 mm	-	20
540652	230x44x6 mm	12 mm	-	20

- Валяк изработен от висококачествени полиамидни влакна с дължина 12 mm.
- Приложение: За нанасяне на алкидни и полиуретанови бои, лакове, грундове, емайл лакове върху средно неравни и гладки повърхности.
- Удобна пластмасова дръжка 300mm
- Roller made from high quality polyamide pile 12 mm.
- Application: For polyurethane and alkid paints, varnish, primers, enamel paints, different type resins and bitumens on medium rough and rouhg surfaces.
- Comfortable plastic handle 300 mm
- Rola fabricat din poliamidă de inalta calitate, cu lungimea firului de 12 mm.
- Aplicatii: Pentru vopseluri poliuretanicе si alchidice, lacuri, grunduri, vopsele emailuri, diverse tipuri de rășini si bitumuri pe suprafețe neregulate.
- Manere din plastic confortabile 300 mm

К-т сито за изцеждане на валяк, гръжка, 4 бр. Валяк / Paint set, pcs / Set 6 pcs unelte pt vopsit



art. N	box	ctn
549801	-	90

- 1x дръжка за валяк 100x240 mm
- 2x валяк полиакрил 100 mm
- 2x валяк дунапен 100 mm
- 1x сито за изцеждане на валяк 110x180 mm
- 1x paint roller handle 100x240 mm
- 2x polyacrylic roller 100 mm
- 2x density foam roller 100 mm
- 1x painting sieve 110x180 mm
- 1x maner trafalet 100x240 mm
- 2x role poliacriliic 100 mm
- 2x role spuma 100 mm
- 1x gratar pentru traalet 110x180 mm

К-т за боядисване, 9 части / Painting set, 9 pcs / Set 9 pcs unelte pt vopsit



art. N	box	ctn
549802	-	50

- 1x найлон 2x3 m; 1x хартиено тиксо 20 mm x 25 m
- 3x четки за боядисване: 40 mm, 50 mm, 65 mm
- 2x валяк дунапен 100 mm
- 1x валяк полиакрил 100 mm.
- 1x дръжка за валяк 100x360 mm
- 1x drop sheet 2x3 m; 1x masking tape 20 mm x 25 m
- 3x paint brushes: 40 mm, 50 mm, 65 mm
- 2x density foam roller 100 mm
- 1x polyacrylic roller 100 mm
- 1x paint roller handle 100x360 mm
- 1x folie pentru acoperire 2x3 m
- 1x banda de hartie adeziva 20 mm x 25 m
- 3x pensule: 40 mm, 50 mm, 65 mm
- 2x role spuma 100 mm; 1x rola poliacriliic 100 mm
- 1x maner trafalet 100x360 mm



Дръжка за валяк / Roller handle / Maner trafalet

art. N	размер (L1,L2,ø2)	box	ctn
540603*	250x300x8 mm	-	48

*Трайно намалена цена / Sale price / Pret de vanzare

- Поцинкована стоманена ос, диаметър 8mm.
- Ергономична двукомпонентна дръжка с отвор за закачане.
- Zink-plated steel rod, diam. 8 mm
- Ergonomic bi-material handle with hanging hole.
- Ax din oțel 8mm, galvanizat
- Mâner ergonomic bi-componente cu orificiu agățat.

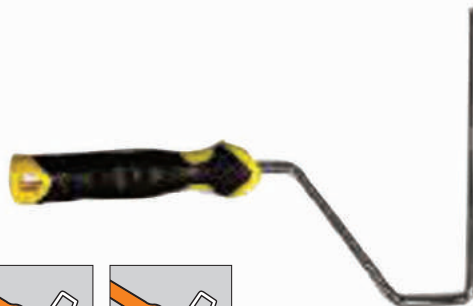

Дръжка за валяк / Roller handle / Maner trafalet

art. N	размер (L1,L2,ø2)	box	ctn
540607	180x300x6 mm	-	100
540608	230x300x6 mm	-	100
540609	250x300x6 mm	-	96

- Поцинкована стоманена ос.
- Ергономична пластмасова дръжка с отвор за закачане.
- Steel rod, zink-plated.
- Ergonomic plastic handle with hanging hole.
- Ax din oțel, galvanizat
- Mâner ergonomic din plastic cu orificiu agățat.

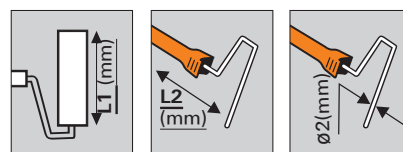

Дръжка за валяк / Roller handle / Maner trafalet

art. N	размер (L1,L2,ø2)	box	ctn
540604	100x270x6 mm	-	100
540605	100x400x6 mm	-	100
540606	100x600x6 mm	-	100

- Поцинкована стоманена ос.
- Ергономична пластмасова дръжка с отвор за закачане.
- Steel rod, zink-plated.
- Ergonomic plastic handle with hanging hole.
- Ax din oțel, galvanizat
- Mâner ergonomic din plastic cu orificiu agățat.

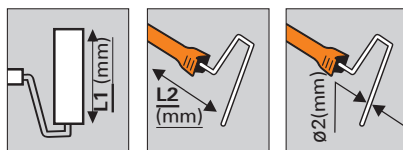

Дръжка за валяк / Roller handle / Maner trafalet

art. N	размер (L1,L2,ø2)	box	ctn
540659	50x200x6 mm	-	100

- Поцинкована стоманена ос.
- Ергономична пластмасова дръжка с отвор за закачане.
- Steel rod, zink-plated.
- Ergonomic plastic handle with hanging hole.
- Ax din oțel, galvanizat
- Mâner ergonomic din plastic cu orificiu agățat.

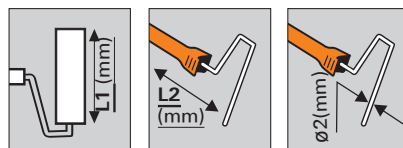



Дръжка за валяк, телескоп. 3 части / Telescopic Roller handle, 3 sections / Maner telescopic trafalet, 3 sectie



art. N	size	box	ctn
540624*	230x(400-900)x6mm	-	24
540611*	230x(400-900)x8mm	-	24

*Трайно намалена цена / Sale price / Pret de vanzare

- Поцинкована стоманена ос.
- Ергономична дръжка с дунапренено покритие.
- Възможност за регулиране на дължината: 40 - 90 cm
- Steel rod, zink-plated.
- Ergonomic handle with density foam cover.
- Possibility for length variation: 40 cm - 90 cm
- Ax din oțel, galvanizat
- Mâner ergonomic acoperit cu spumă.
- Posibilitatea ajustării lungimii: 40 cm - 90 cm.

Телескопичен утължител, 2 части / Steel extention pole, 2 sections / Maner prelungitor pentru trafalet, 2 sectie



art. N	size	box	ctn
540618	300-600 mm	-	24
540619	600-1200 mm	-	24
540620	900-1800 mm	-	24
540622	1200-2400 mm	-	24

- Стоманено тяло
- Steel body
- Corp din oțel

Ваничка пластмасова / Plastic paint tray / Tava plastic pentru vopsea



art. N	size	box	ctn
540692	180 mm	-	100
540693	230 mm	-	40
540694	250 mm	-	50

Сито за изцеждане на валяк / Painting sieve / Gratar trafalet

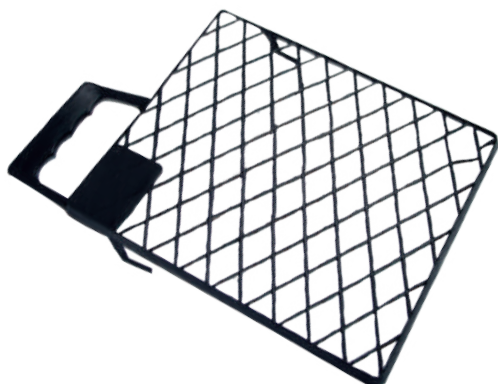

art. N	size	box	ctn
541201	180mm	-	350
541202	230mm	-	100
541203	250mm	-	100



Четка за боядисване, естествен косъм / Paint brush, natural filament / Pensula maner plastic, par natural

art. N	size	box	ctn
540670	25 mm	40	480
540671	40 mm	30	360
540672	50 mm	30	360
540673	65 mm	20	240
540674	75 mm	20	240

- Подходящи за нанасяне на алкидни бои и грундове
- Пластмасова дръжка
- Suitable for application of alkid paints and primers
- Plastic handle
- Icarrea vopselurilor alchidice si a grundurilor
- Măner din plastic



Четка за боядисване "BASIC", естествен косъм / Paint brush, natural filament "BASIC" / Pensula maner plastic, par natural "BASIC" natural

art. N	size	box	ctn
544202	25 mm	50	600
544203	40 mm	50	600
544204	50 mm	40	480
544205	65 mm	30	360
544206	75 mm	18	216

- Подходящи за нанасяне на алкидни бои и грундове.
- Пластмасова дръжка.
- Suitable for application of alkid paints and primers.
- Plastic handle.
- Potrivit pentru aplicarea vopselurilor alchidice si a grundurilor.
- Măner din plastic.



Четка за боядисване изкуствен косъм / Paint brush, artificial filament / Pensula maner plastic, par artificial

art. N	size	box	ctn
540681	40 mm	30	360
540682	50 mm	20	240
540683	65 mm	20	240

- Подходящи за нанасяне на вододисперсни бои и грундове.
- Пластмасова дръжка.
- Suitable for application of water-dispersible paints and primers.
- Plastic handle.
- Potrivit pentru aplicarea vopselurilor alchidice si a grundurilor
- Măner din plastic.





Четки за боядисване, к-м 3 бр. / Paint brush set 3 pcs / Pensule set 3 pcs



art. N	size	box	ctn
340111	20, 40, 50 mm	-	150

- Четки с размери: 25mm, 40mm, 50mm.
- Изкуствен косъм.
- Дървена дръжка.
- Brushes with sizes: 25mm, 40mm, 50mm.
- Artificial filament.
- Wooden handle.
- Pensule 25mm, 40mm, 50mm.
- Filament artificial.
- Maner din lemn.

Четки за боядисване, к-м 5бр. / Paint brush set 5 pcs / Pensule set 5 pcs



art. N	size	box	ctn
340112	-	-	100

- Четки с размери: 13mm, 25mm, 40mm, 50mm, 65mm.
- Изкуствен косъм.
- Дървена дръжка.
- Brushes with sizes: 13mm, 25mm, 40mm, 50mm, 65mm.
- Artificial filament.
- Wooden handle.
- Pensule 13mm, 25mm, 40mm, 50mm, 65mm.
- Filament artificial.
- Maner din lemn.

Четка баганарка, ест. косъм / Paint brush, natural filament / Bidinea, par natural



art. N	size	box	ctn
540663	30x100 mm	20	120
540664	40x140 mm	20	120
540665	50x150 mm	20	120

- Пластмасова дръжка
- Plastic handle
- Măner din plastic

Четка баганарка, изкуствен косъм / Paint brush, artificial filament / Bidinea suport lemn, par artificial



art. N	size	box	ctn
540660	50x140 mm	8	144
540661	70x150 mm	10	120
540662	70x170 mm	12	144

- Релефна пластмасова дръжка.
- Дървена основа на четката.
- Embossed plastic handle.
- Wooden base of the brush.
- Măner din plastic
- Periei de bază din lemn.



КОД ARTICLE	ВИД / TYPE	ПРЕДНАЗНАЧЕНИЕ / PURPOSE											ПОВЪРХНОСТ SURFACE				
		Дължина на нишката в мм / Length of thread in mm /	Алкидни бои и лакове Alkyd paints and varnishes	Хлоркаучукови бои Chlorine-rubber paint	Полиуретанови бои и лакове Polyurethane paints and varnishes	Силиконови бои Silicone Paints	Силикатни бои Silicate paints	Фасадни бои Facade paint	Лакове с разтворители Varnish with solvents	Лакове на водна основа Water-based varnishes	Гъсти бои и смеси Thick paint and mixtures	Водоразтворими бои Water-dispersed paints	Епоксидни бои и лакове Epoxy paints and varnishes	Акрилни бои и лакове Acrylic paints and varnishes	Гладка / Smooth	Средно груба Average roughness	Много груба / Very rough
540697 540653 540648 540649 540655	Валяк полиамид къса нишка Roller polyamide	12	xxx	x	x	x	xx	xxx		x		xxx	x		xx	xxx	
540654 540656 540657 540658 540698	Валяк полиамид дълга нишка Roller polyamide	18	xxx	xx	x	x	x	xxx				xxx	x			xxx	xx
540641 540642 540690	Валяк мини велур Rollers Mini Radiator	4	xx	x	x				xx	xxx		x	x		xxx		
540643	Валяк дунапрен екстра High density foam mini roller		xx							xxx		xxx			xxx		
540645 540646	Валяк мини заоблен FLOK Flocked foam mini roller		xx							xxx		xxx			xxx		
540639 540640	Валяк полиамид мини Acrylic mini roller	12	xxx	x	x	x	xx	xxx		x		xxx	x		xxx	x	

x - възможно xx - подходящ xxx - много подходящ
 x - possible xx - suitable xxx - very suitable
 x - posibil xx - adecvat xxx - foarte adecvat





КОД ARTICLE	ТИП ВАЛЯК ROLLER TYPE	СЪСТАВ НА МАТЕРИАЛА/ MATERIAL COMPOSITION					
		Полиамид гъст / Thick polyimide	Полиестерна пена / Polyester foam	Полиамид рехав / Polyamide loose	Полиакрил / Acrylic	Вълна / Wool	Полиестер / Polyester
540648 540649 540653 540655 540697	Валяк полиамид къса нишка Roller polyamide			X	X		
540654 540656 540657 540658 540698	Валяк полиамид дълга нишка Roller polyamide			X	X		
540641 540642 540690	Валяк мини велур Rollers Mini Radiator				X	X	
540643	Валяк дунапрен екстра Radiator Mini Roller		X				
540645 540646	Валяк мини заоблен Radiator Mini Roller		X				
540639 540640	Валяк полиамид мини Rollers Mini Radiator			X	X		





Tukco хартиено / Masking tape / Banda hartie

art. N	size	box	ctn
930117	38 mm	7	70
930122	50 mm	10	50

- Дължина 18м.
- За предпазване на повърхности от замърсяване при боядисване и лакиране.
- Length 18m.
- For surface protection during painting and varnishing.
- Lungime 18m.
- Pentru protejarea suprafetelor in timpul vopsirii si zugravirii



Tukco двоинозалепащо, бяло / Mounting tape, white / Banda dublu adeziva, alb

art. N	size	box	ctn
930104	18mm x 4m	-	144
930106	24mm x 4m	-	72
930108	30mm x 4m	-	60
930110	36mm x 4m	-	48
930111	48mm x 4m	-	36

- Подходящо за залепване на леки предмети и декорация върху всякакъв вид стени, керамични плочки и дървени повърхности.
- Suitable for decorations on the wall, ceramics and wooden surface.
- Potrivita pentru decorarea peretilor, placilor ceramice si suprafetelor din lemn.



Покривен найлон / Drop sheet / Folie pentru acoperit

art. N	size	box	ctn
939944	4x5.0m	-	100
939945	4x12.5m	-	40

- Плътност 7 микрона
- Thickness 0.007mm
- Densitate 0.007mm

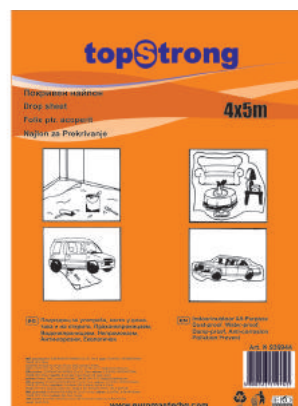

Стреч фолио / Stretch film / Folie

art. N	size	box	ctn
950201	0.023mm/100m/1.200kg	-	6

- Плътност 23 микрона
- Thickness 0.023mm
- Densitate 0.023mm





Пистолет за силикон, алуминиев / Caulking gun, aluminium / Pistol tub aluminiu pt mastic siliconic



art. N	size	box	ctn
491301	9"/225 mm	-	30

- Алуминиев корпус, затворен тип.
- Пластмасови уплътнения/капаци.
- Вместимост на тръбата: до 600 ml.
- Aluminium body, closed type.
- Plastic closing caps.
- Tube capacity: up to 600 ml.
- Corp din aluminiu.
- Capace din plastic.
- Capacitatea tubului: pana la 600ml.

Пистолет за силикон, алуминиев / Caulking gun, aluminium / Pistol tub aluminiu pt mastic siliconic



art. N	size	box	ctn
491307	15"/375 mm	-	20

- Алуминиев корпус, затворен тип.
- Пластмасови уплътнения/капаци.
- Вместимост на тръбата: до 850 ml.
- Aluminium body, closed type.
- Plastic closing caps.
- Tube capacity: up to 850 ml.
- Corp din aluminiu.
- Capace din plastic.
- Capacitatea tubului: pana la 850ml.

Пистолет за силикон, алуминиев / Caulking gun, aluminium / Pistol tub aluminiu pt mastic siliconic



art. N	size	box	ctn
491401	15"/375 mm	-	24

- Алуминиев корпус, затворен тип.
- Алуминиеви уплътнения/капаци.
- Ергономичен алуминиев спусък
- Избутващ механизъм с намалено усилие при натиск; 2бр. глави (фунии).
- Вместимост на тръбата: до 850 ml.
- Aluminium body, closed type.
- Aluminium closing caps.; 2pcs funnels.
- Ergonomic aluminium trigger.
- Mechanism for lower pushing efforts.
- Tube capacity: up to 850 ml.

Пистолет за силикон, гум. гръжка / Caulking gun, rubber handle / Pistol pt tub silicon, maner cauciucat



art. N	size	box	ctn
491304	9"/225 mm	-	24

- Лека метална конструкция, хромиран.
- Тежест: 400g.
- Полуотворен тип.
- Гумирана дръжка.
- Lightweight metal body, chromium plated.
- Semi-opened type.
- Weight: 400g.
- Rubber handle.
- Corp din metal, cromat.
- Greutate: 400g.
- Semi deschis
- Maner cauciucat.

Пистолет за силикон, пластмасов / Caulking gun, plastic body / Pistol pt tub silicon, corp de plastic



art. N	size	box	ctn
491306	9"/225 mm	-	24

- Пластмасово тяло, полуотворен тип.
- Plastic body, semi-opened type.
- Corp din plastic



Пистолет за силикон / Caulking gun / Pistol pentru tub silicon

art. N	size	box	ctn
491303	9"/225 mm	-	50

- Олекотена метална конструкция, полуотворен тип
- Тежест: 275g.
- Lightweight metal body, semi-opened type.
- Weight: 275g.
- Corp din metal, categorie ușoară, semi-deschis.
- Greutate: 275g.



Пистолет за силикон, лук / Caulking gun lux / Pistol pentru tub silicon, schelet

art. N	size	box	ctn
491302	9"/225 mm	-	40

- Олекотена метална конструкция, тип "скелет".
- Лесно освобождаване на избутващия механизъм.
- Lightweight metal body, "skeleton" type.
- Pushing mechanism with easy release.
- Corp din metal, categorie ușoară, tip "schelet".
- Tragaci care se poate elibera cu usurint

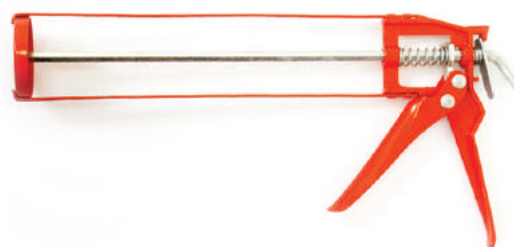

Пистолет за полиуретанова пяна / Polyurethane mounting foam gun / Pistol pt spuma poliuretanică

art. N	size	box	ctn
491311	-	-	20

- Алюминиево тяло.
- Стоманен никелиран спусък.
- Игла от неръждаема стомана.
- Регулиращ винт за лесен контрол върху потока на пяна.
- Aluminium alloy body
- Iron trigger, nickel plated.
- Stainless steel needle.
- Adjustable screw for easy control on foam flow.
- Corp din aliaj de aluminiu, tragaci metalic
- Trăgaci fier, nichelate.
- Ac din otel inox.
- Șurub reglabil pentru control ușor asupra fluxului de spumă.



Пистолет за полиуретанова пяна / Polyurethane mounting foam gun / Pistol pt spuma poliuretanică

art. N	size	box	ctn
491309	-	-	20

- Алюминиево тяло.
- Стоманен никелиран спусък.
- Игла от неръждаема стомана.
- Тефлонов адаптор.
- Alluminium alloy body.
- Iron trigger, nickel plated.
- Stainless steel needle.
- Teflon adaptor.
- Corp din aliaj de aluminiu.
- Trăgaci fier, nichelate.
- Ac din otel inox.
- Adaptor teflon polisat.





Пистолет за полиуретанова пяна / Polyurethane mounting foam gun / Pistol pt spuma poliuretanică



art. N	size	box	ctn
491310	-	-	20

- Алюминиево тяло.
- Стоманен никелиран спусък.
- Цинков адаптор.
- Игла от неръждаема стомана.; Медна дюза.
- Aluminium alloy body
- Iron trigger, nickel plated
- Universal zinc alloy adapter.
- Stainless steel needle.
- Copper nozzle.
- Corp din aliaj de aluminiu.
- Tragaci metalic nichelat.
- Ac din otel inox.
- Adaptor universal din aliaj de zinc.
- Duza da cupru

Пистолет за полиуретанова пяна / Polyurethane mounting foam gun / Pistol pt spuma poliuretanică



art. N	size	box	ctn
491312	-	-	20

- Стоманен никелиран спусък.
- Игла от неръждаема стомана.
- Пластмасова дръжка.
- Iron trigger, nickel coated
- Stainless steel needle.
- Plastic handle.
- Tragaci metalic nichelat.
- Ac din otel inox.
- Maner plastic.

Маламашка, гумена гръжка / Plastering trowel / Gletiera fara dinti



art. N	size	box	ctn
320101	280x120 mm	5	60

- За шпакловане и разнасяне на гипсови покрития и лепила.
- Полирана стомана.
- Гумена дръжка.
- For plastering and spreading out of gypsum and building glues.
- Polished surface.
- Rubber handle.
- Pentru driscuirea si intinderea gipsurilor si adezivilor pentru constructii
- Oțel lustruit.
- Maner din cauciuc.

Маламашка с гребен, гумена гръжка / Plastering trowel / Gletiera cu dinti



art. N	size	box	ctn
320102	280x120 mm	5	60

- За шпакловане и разнасяне на гипсови покрития и лепила.
- Полирана стомана.
- Гумена дръжка.; Гребен - 8 mm.
- For plastering and spreading out of gypsum and building glues.
- Polished surface.
- Rubber handle.; Teeth - 8 mm.
- Pentru driscuirea si intinderea gipsurilor si adezivilor pentru constructii
- Oțel lustruit.; Maner din cauciuc.
- Dinti - 8 mm.



Маламашка, пластмасова гръжка / Plastering trowel, plastic handle / Gletiera maner plstic

art. N	size	box	ctn
320105	280x120mm	5	60

- За шпакловане и разнасяне на гипсови покрития и лепила.
- Пластмасова дръжка.
- For plastering and spreading out of gypsum and building glues.
- Plastic handle.
- Pentru driscuirea si intinderea gipsurilor si adezivilor pentru constructii
- Mâner din plastic.



Маламашка с гребен, пластмасова гръжка / Plastering trowel, plastic handle / Gletiera, maner plstic cu dinti

art. N	size	box	ctn
320106	280x120mm	5	60

- За шпакловане и разнасяне на гипсови покрития и лепила.
- Пластмасова дръжка.
- Гребен - 8 mm.
- For plastering and spreading out of gypsum and building glues.
- Plastic handle
- Teeth - 8 mm.
- Pentru driscuirea si intinderea gipsurilor si adezivilor pentru constructii.
- Mâner din plastic.
- Dinti - 8 mm.



Маламашка, гървена гръжка / Plastering trowel, wooden handle / Gletiera maner lemn

art. N	size	box	ctn
320103	280x120mm	5	60

- За шпакловане и разнасяне на гипсови покрития и лепила.
- Полирана стомана.
- Дървена дръжка.
- For plastering and spreading out of gypsum and building glues.
- Polished surface.
- Wooden handle.
- Pentru driscuirea si intinderea gipsurilor si adezivilor pentru constructii.
- Oțel lustruit.
- Mâner din lemn.



Маламашка с гребен, гървена гръжка / Plastering trowel, wooden handle with teeth / Gletiera maner lemn cu dinti

art. N	size	box	ctn
320104	280x120mm	5	60

- За шпакловане и разнасяне на гипсови покрития и лепила.
- Полирана стомана.; Дървена дръжка.
- Гребен - 8 mm.
- For plastering and spreading out of gypsum and building glues.
- Polished surface.; Wooden handle.
- Teeth - 8 mm.
- Pentru driscuirea si intinderea gipsurilor si adezivilor pentru constructii.
- Oțel lustruit.; Mâner din lemn.
- Dinti - 8 mm.





Маламашка, дървена гръжка / Plastering trowel, wooden handle / Gletiera, maner lemn



art. N	size	box	ctn
321001	380x130mm	-	25

- За шпакловане и разнасяне на гипсови покрития и лепила.; Неръждаема стомана, полирана.
- Дървена дръжка затворен тип.
- For plastering and spreading out of gypsum and building glues.; Stainless steel, polished.
- Wooden handle, closed type
- Pentru driscuirea si intinderea gipsurilor si adezivilor pentru constructii
- Otel inox, lustruit.; Maner lemn, tip Închis.

Маламашка с гребен, дървена гръжка / Plastering trowel, wooden handle with teeth / Gletiera maner lemn cu dinti



art. N	size	box	ctn
321002	380x130mm	-	25

- За шпакловане и разнасяне на гипсови покрития и лепила.
- Неръждаема стомана, полирана.
- Дървена дръжка затворен тип.; Гребен - 8 mm.
- For plastering and spreading out of gypsum and building glues.; Stainless steel, polished.
- Wooden handle, closed type; Teeth - 8 mm.
- Pentru driscuirea si intinderea gipsurilor si adezivilor pentru constructii; Otel inox, lustruit.
- Maner lemn, tip Închis.; Dinti - 8 mm.

Маламашка, пластмасова / Plastering trowel, plastic / Gletiera din plastic



art. N	size	box	ctn
320116	280x130mm	5	60

- За нанасяне на минерални и структурни мазилки.
- For application of mineral and structural plasters.
- Pentru discuirea si intinderea gipsurilor si adezivilor pentru constructii.

Пергащка, пластмасова / Plastering trowel, plastic / Gletiera din plastic



art. N	size	box	ctn
320115	280x140mm	-	36

- За нанасяне на минерални и структурни мазилки.
- For application of mineral and structural plasters.
- Pentru discuirea si intinderea gipsurilor si adezivilor pentru constructii.

Маламашка, пореста гума / Foam float trowel / Gletiera pt rosturi



art. N	size	box	ctn
320301	215x135mm	4	48

- Пореста гума.
- Дървена дръжка.
- За фугиране.
- Foam float.
- Wooden handle.
- For grouting.
- Spumă float
- Maner din lemn.
- Pentru curatarea si umplerea rosturilor.



Маламашка, пореста гума / Foam float trowel / Gletiera pt rosturi

art. N	size	box	ctn
320302	280x90mm	4	48

- Пореста гума.
- Дървена дръжка.
- Foam float.
- Wooden handle.
- Spumă float.
- Maner din lemn.



Маламашка, пореста гума 10mm / Foam float trowel 10mm / Gletiera pt rosturi 10mm

art. N	size	box	ctn
320132	130x250mm	-	30

- Пореста гума с дебелина 10mm.
- Пластмасова дръжка.
- За фугиране.
- Foam float 10mm.
- Plastic handle.
- For grouting.
- Material: Spumă 10mm.
- Maner plastic.
- Pentru curatarea si umplerea rosturilor



Маламашка, гума / Rubber trowel / Gletiera burete

art. N	size	box	ctn
320133	130x270mm	-	30

- Дебелина на гумата - 6mm.
- Пластмасова дръжка.
- За фугиране.
- Rubber thickness - 6mm.
- Plastic handle.
- For grouting.
- Grosimea cauciucului - 6mm.
- Maner plastic.
- Pentru curatarea si umplerea rosturilor.



Маламашка, гунапен / Single float trowel / Gletiera burete

art. N	size	box	ctn
320131	140x270mm	-	20

- Дебелина на дунапена 25mm.
- Пластмасова дръжка.
- За почистване на фаянс след фугиране.
- Foam thickness - 25mm.
- Plastic handle.
- For cleaning faience after grouting.
- Material: Spumă 25mm.
- Maner plastic.
- Pentru curatarea si umplerea rosturilor.



Ренге за умонг / Planer / Gletirea pt razuit

art. N	size	box	ctn
320134	160x350mm	-	15

- Пластмасова дръжка
- Plastic handle
- Plastic mâner

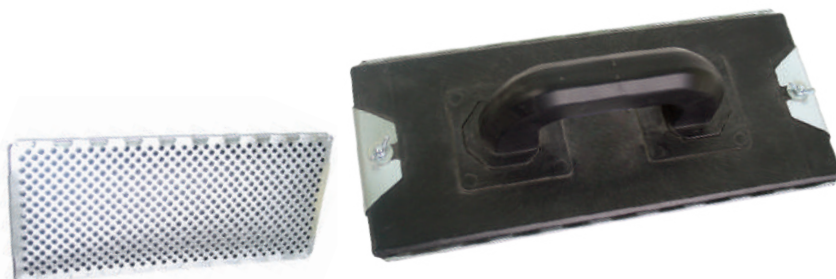



Шлайер с гръжка / Sanding block / Dispozitiv pt slefuit manual



art. N	size	box	ctn
320130	230x105mm	-	30

- Пластмасова дръжка
- Plastic handle
- Plastic mâner

Мистрия, гървена гръжка / Bricklaying trowel / Mistrie



art. N	size	box	ctn
320107	7"/175 mm	10	120
320109	8"/200 mm	10	120

Мистрия, пластмасова гръжка / Bricklaying trowel / Mistrie



art. N	size	box	ctn
320108	7"/175 mm	5	60
320110	8"/200 mm	5	60

Шнакла, гървена гръжка / Scraper, wooden handle / Spaclu, maner lemni



art. N	size	box	ctn
320407	1_1/2"/ 40mm	20	240
320408	2"/ 50mm	20	240
320409	2_1/2"/ 60mm	20	240
320410	3"/ 75mm	20	240
320411	3_1/2"/90mm	20	240
320412	4"/100mm	20	240

Шнакла, гървена гръжка / Scraper, wooden handle / Spaclu, maner lemni



art. N	size	box	ctn
320414	40mm	20	240
320415	50mm	20	240
320416	65mm	20	240
320417	75mm	20	240
320418	100mm	20	240

- Ергономична дървена дръжка.
- Въглеродна стомана с хромирано покритие.
- Двучовково закрепяне на дръжката.
- Ergonomic wooden handle.
- Carbon steel, chrome plated.
- Two-points fastening of the handle.



Шнакла, двуконпонентна дрџка / Scraper, bi-material handle / Spaclu, maner plastic

art. N	size	box	ctn
320750	40mm	10	120
320751	50mm	10	120
320752	65mm	10	120
320753	75mm	10	120
320754	100mm	10	120
320755	125mm	10	120

- Двуконпонентна дрџка - гума и пластмаса.
- Bi-material handle - rubber and plastic.
- Măner bi-material confortabil - cauciuc și plastic.



Шнакла фасадна, пластмасова дрџка / Scraper, plastic handle / Spaclu, maner plastic

art. N	size	box	ctn
324201	150mm	-	60
324202	200mm	-	60

- Нерџдаема стомана
- Пластмасова дрџка
- Stainless steel
- Plastic handle
- Otel inox
- Maner plastic



Шнакли за кум, к-м 4 броя / Scrapers, 4pcs set / Set 4 spacluri flexibile

art. N	size	box	ctn
329912	-	-	120

- Размер: 50mm, 80mm, 100mm, 120mm.
- Нерџдаема стомана.
- Size: 50mm, 80mm, 100mm, 120mm
- Stainless steel.
- Dimensiuni: 50mm, 80mm, 100mm, 120mm.
- Stainless steel.

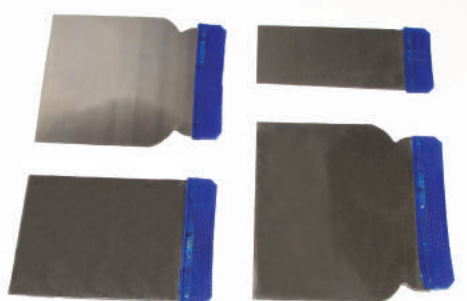

Машина за прџкание на мазилка / Sprayer machine / Dispensor

art. N	size	box	ctn
329911	-	-	12



Канчок за строителен разтвор / Mason's pan / Cancioc

art. N	size	box	ctn
329929	170mm	-	80

- Дървена дрџка
- Wooden handle
- Măner din lemn





Кръстчета за фуги, плик / Set Telcross distantion / Set distantiere



art. №	size	бр. в плик / pcs in bag	ctn
329917	2.5 mm	200	100
329913	3.0 mm	150	100
329914	4.0 mm	100	100
329916	5.0 mm	100	100
329915	6.0 mm	75	100

Отвес, блустер / Plumb ruler / Plumb pt. trasat

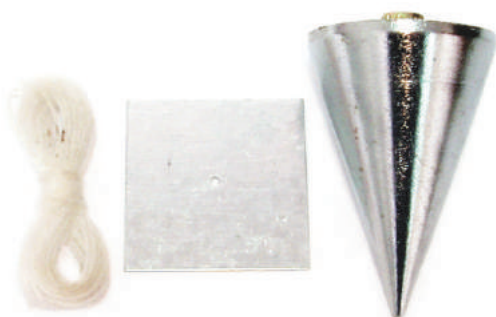

art. N	size	box	ctn
320902	200g	10	120
320904	300g	10	60

Катинар сув / Iron Pad lock / Lacat metal

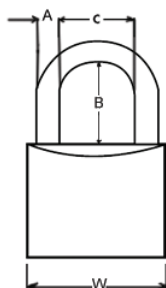

art. N	A	B	C	size W	weight	box	ctn
500501	3mm	12mm	10mm	20mm	29g	50	600
500502	4mm	15mm	13mm	25mm	46g	50	600
500503	5mm	20mm	15mm	32mm	66g	40	240
500504	6mm	23mm	20mm	38mm	110g	40	240
500515	7mm	30mm	26mm	50mm	160g	20	120
500505	8mm	30mm	26mm	50mm	222g	20	120
500516	7mm	35mm	30mm	63mm	300g	10	60
500506	9mm	35mm	30mm	63mm	350g	10	60
500507	10mm	44mm	42mm	75mm	580g	8	48

- 3 ключа.
- 3 keys.
- 3 chei.

Катинар сув на блустер / Iron Pad lock, skin card / Lacat metal pe blister



art. N	size W	weight	box	ctn
500512	38mm	112g	10	120
500513	50mm	155g	10	120
500514	63mm	270g	6	72

- 3 ключа.
- 3 keys.
- 3 chei.

Катинар сув, дълго рамо / Iron pad lock, long shackle / Lakat metal - lung

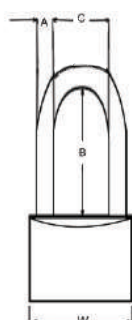

art. N	A	B	C	size W	weight	box	ctn
500508	6mm	65mm	20mm	38mm	160g	10	120
500509	8mm	65mm	26mm	50mm	285g	5	60

- 3 ключа.
- 3 keys.
- 3 chei.



Катинар месинг / Brass pad lock / Lacat bronz

art. N	A	B	C	size W	weight	box	ctn
500702	3mm	12mm	10mm	20mm	30g	50	600
500703	4mm	15mm	13mm	25mm	45g	50	600
500704	5mm	20mm	15mm	32mm	98g	40	240
500705	6mm	23mm	20mm	38mm	123g	40	240
500706	8mm	30mm	26mm	50mm	221g	20	120
500707	9mm	35mm	30mm	63mm	390g	10	60

- 3 ключа.
- 3 keys.
- 3 chei.

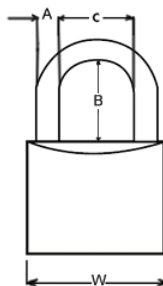

Катинар месинг, дълго рамо / Brass pad lock, long shackle / Lacat bronz-lung

art. N	A	B	C	size W	weight	box	ctn
500709	5mm	60mm	20mm	38mm	142g	10	120
500711	8mm	60mm	26mm	50mm	250g	10	60

- 3 ключа.
- 3 keys.
- 3 chei.

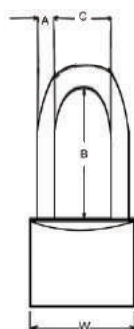

Катинар тун "руску", сив / Iron pad lock, grey / Lacat metal-gri

art. N	A	B	C	size W	weight	box	ctn
509901	9mm	42mm	38mm	70mm	545g		60

- 3 ключа.
- 3 keys.
- 3 chei.

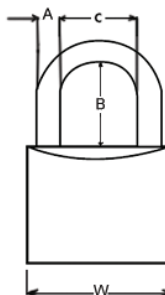

Катинар тун "руску", цилиндричен / Iron pad lock, cylindric / Lacat metal-cilindric

art. N	size / weight	box	ctn
509903	85mm / 352g	-	48

- 3 ключа.
- 3 keys.
- 3 chei.



Катинар тун "руску", с бронировка / Iron pad lock, shielded / Lacat metal-protejat

art. N	size	weight	box	ctn
509902	90mm	300g	-	20

- 3 ключа.
- 3 keys.
- 3 chei.





Катунар с верига / Iron pad lock with chain / Lacat metal cu lant



art. N	size / weight	box	ctn
509904	50mm / 545g	-	30

Брава за пощенска кутия / Postbox lock / Lacat



art. N	size	box	ctn
530106	-	25	300

- За пощенска кутия
- For mailbox
- Pentru cutie poștală

Брава / Drawer lock / Zavor



art. N	size	box	ctn
530113	-	12	240

- За шкаф / пощенска кутия.
- For drawer / mailbox.
- Pentru cabinet / cutie poștală.

Брава касова с 5 ключа / Door lock with 5 keys / Incuietoare usa cu 5 chei

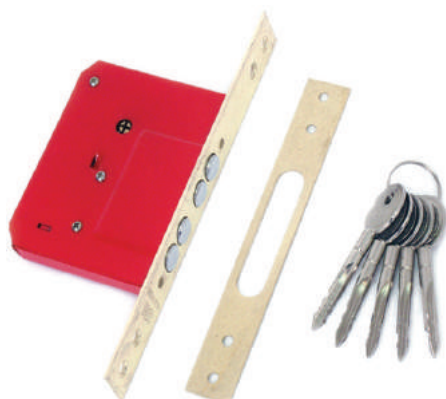

art. N	size	box	ctn
530108	-	-	30

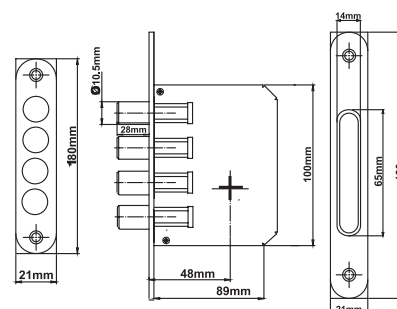



Патрон за брава с 3 ключа / Cylinder with 3 keys / Butuc broasca cu 3 chei

art. N	size	box	ctn
530307	70mm	10	120

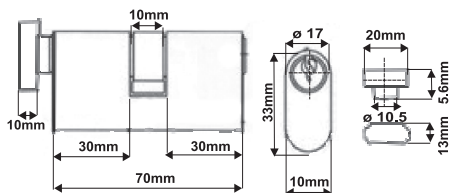

- С кръгла ръкохватка.
- With round hand lock.
- Cu blocare mână cilindric.

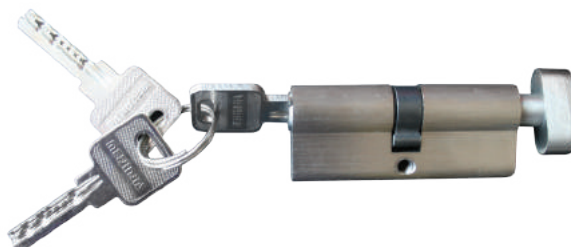

Патрон за брава / Cylinder / Butuc broasca

art. N	size	box	ctn
530308	60mm	10	120
530309	60mm	10	120

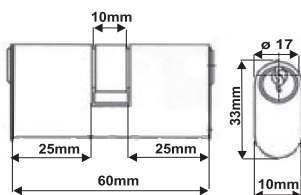

- 530308 6 ключа / 6 keys / 6 chei
- 530309 3 ключа / 3 keys / 3 chei



Резе / Iron tower bolt / Zavor

art. N	size	box	ctn
530511	4"/100mm	2	200

- C Top stop
- With Top stop
- Cu Top stop

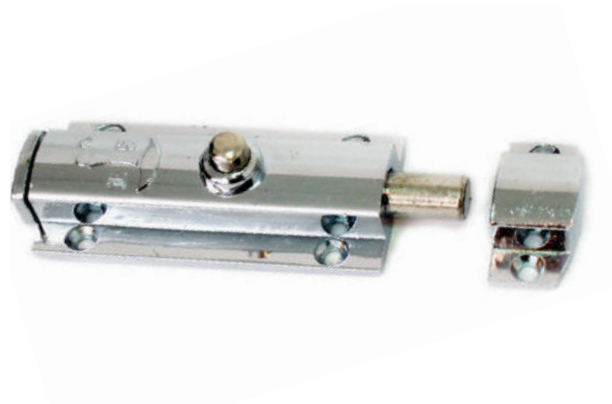

Магнит за шкаф / Cupboards magnet / Magnet inchidere usa

art. N	size	box	ctn
530904	60mm	18	900





Магнит за шкаф, бял, лукс / Cupboards magnet, white / Magnet inchidere usa, aib



art. N	size	box	ctn
530905	60mm	50	900

Механизъм за чекмедже / Slide drawers / Glisiere rafturi

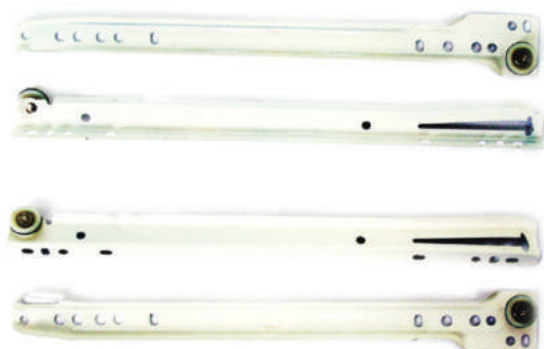

art. N	size	box	ctn
531105*	22"/550mm	-	25

*Трайно намалена цена / Sale price / Pret de vanzare

Автомат за врата / Door closer / Amortisor inchidere usa

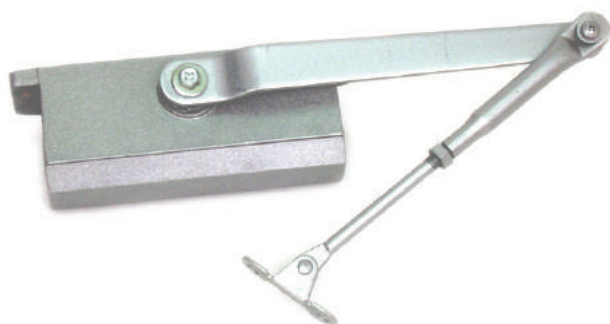

art. N	size	box	ctn
539901*	-	-	10
539902 **	-	-	10

* бял / white / alb

** сив / silver / argintiu

Кутия пощенска / Mailbox / Cutie postala



art. N	size	box	ctn
939902	-	-	20

- Единична
- Single mail box
- Cutie poștală unică



Верига, Връзка / Chain din / Lant

art. N	size	box	ctn
521901	3mm / 0.16kg/m	10	300
521902	4mm / 0.29kg/m	5	150
521903	5mm / 0.5kg/m	3	90
521904	6mm / 0.8kg/m	2	60
521905	8mm / 1.4kg/m	1	30
521906	10mm / 2.2kg/m	1	30



Верига на макара / Link chain / Lant

art. N	size	box	ctn
521911	3mm / 120m	-	120
521912	4mm / 70m	-	70
521913	5mm / 50m	-	50
521914	6mm / 30m	-	30
521915	8mm / 15m	-	15

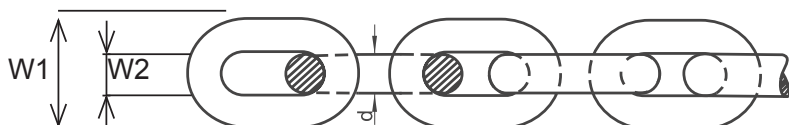

размер d mm	натоварване		тегло на метър кг	ширина	
	работно кг	пробно кг		вътрешна W2/mm	външна W1/mm
4	200	500	0.32	4.8	14
5	320	800	0.50	6.0	17
6	400	1000	0.80	7.2	20
8	800	2000	1.40	9.6	26



Ръчна количка / Wheelbarrow / Роаба

art. N	size	box	ctn
499985	-	-	-





Макара / Single wheel swivel pulley / Scripete

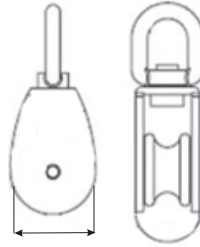

art. N	size	box	ctn
520111	1/2"/13mm	-	100
520101	3/4"/20mm	50	1000
520102	1"/25mm	20	500
520103	1_1/2"/35mm	20	240
520104	2"/50mm	10	100

арт. N	размер "inch	размер A мм	диаметър на въжето inch	тегло 100бр./ kg
520111	1/2"	13	3/16	2.4
520101	3/4"	20	1/4	4.8
520102	1"	25	3/8	11.5
520103	1_1/2"	35	7/16	21.0
520104	2"	50	1/8	2.3

Макара / Single wheel swivel pulley / Scripete

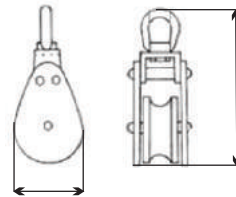

art. N	size	box	ctn
520105	3"/75mm	-	20
520106	4"/100mm	-	15
520107	5"/125mm	-	10

арт. N	размер "	размер A мм	размер L мм	диаметър на въжето inch	тегло kg
520105	3"	75	165	1/4	0.64
520106	4"	95	215	3/8	1.65
520107	5"	115	235	3/8	2.40

Макара с кукла / Single wheel pulley with snatch block hook / Scripete cu carlig

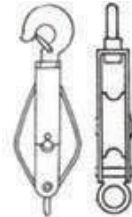

art. N	size	box	ctn
520108	3"/75mm	5	10
520109	4"/100mm	4	8
520110	5"/125mm	2	4

Арт. N		520108	520109	520110
диаметър на ролката	mm	75	100	125
за въже до Ø	mm	8	10	13
товароподемност	кг	500	1000	1500
единично тегло	кг	1.70	3.2	5.00

Кукла за лебегка / Slip hook / Carlig cu ancora

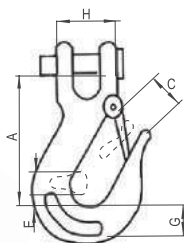

art. N	size	box	ctn
521701	5/16"	5	100
521702	3/8"	5	50
521703	1/2"	4	20

арт. N	товароносимост W.L.L тона	A мм	C мм	E мм	G мм	H мм	единично тегло кг
521701	0.75	75	31	17	23	29	0.34
521702	1.00	80	35	26	29	34	0.544
521703	2.00	100	47	33	40	46	1.27



Карабинка / Snap hook / Carlig siguranta

art. N	size	box	ctn
520301	5x50mm	30	1500
520302	6x60mm	20	1000
520303	8x80mm	8	400
520304	10x100mm	10	200
520306	11x120mm	2	100
520307	12x140mm	5	100
520308	14x180mm	5	50



Арт. N	размер mm	диаметър на тялото d mm	височина l mm	ширина на отвора m mm	единично тегло 100бр./кг
520301	5x50	5	50	7	1.80
520302	6x60	6	60	8	2.80
520303	8x80	8	80	10	7.00
520304	10x100	10	100	12	14.40
520306	11x120	11	120	16	19.20
520307	12x140	12	140	22	27.00
520308	14x180	14	180	28	50.00

Карабинка с винт / Snap hook with screw / Carlig siguranta cu surub

art. N	size	box	ctn
520315	6mm	8	800
520316	8mm	6	300
520317	10mm	4	200

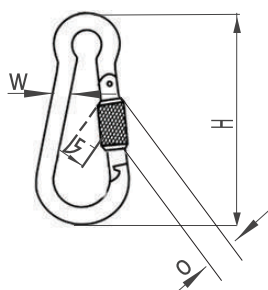

Арт. N	размер Ø мм W	дължина H mm	отвор O mm	единично тегло 100бр./кг
520315	6	60	6.5	3
520316	8	80	8	7.50
520317	10	100	12	16

Скоба за метален кабел / Wire rope clips / Colier fixare cabluri

art. N	size	box	ctn
520501	5mm	15	1500
520502	6.5mm	10	500
520503	8mm	20	1000
520504	10mm	10	500
520505	13mm	5	250
520506	16mm	10	200
520507	19mm	10	100
520508	22mm	5	50
520509	25mm	5	50

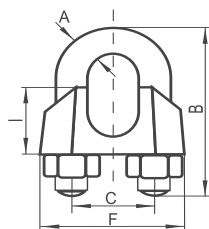

Арт. N	размер mm	диаметър на скобата A mm	височина на скобата B mm	широчина на скобата C mm	дължина на тялото F mm	височина на тялото I mm	тегло за 100 бр. кг
520501	5	5	24	11	23	10	1.5
520502	6.5	5	28	13	26	11	2.1
520503	8	6	34	16	30	15	4.1
520504	10	8	42	19	36	17	6.8
520505	13	10	55	24	42	21	13.0
520506	16	12	63	29	50	26	21.0
520507	19	12	75	32	54	30	28.0
520508	22	14	85	37	61	34	40.0
520509	25	14	95	41	65	37	44.0



Скоба "D" форма с винт / Dee Shackle / Ancora "D" cu surub

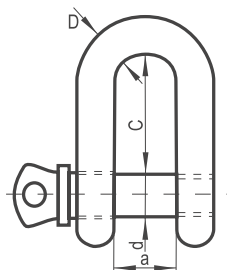

art. N	size	box	ctn
520706	6mm	10	1000
520707	8mm	10	500
520708	10mm	6	300
520709	12mm	10	150
520710	16mm	7	70

Арт. N	товаро- подемност kg	тяло Ø D mm	болт Ø d mm	ширина a mm	височина C mm	единично тегло kg
520706	100	5	6	9.5	25	0.032
520707	200	7	8	12	32	0.057
520708	320	9	10	13.5	38	0.126
520709	520	11	12	19	51	0.235
520710	800	13.5	16	20	64	0.494

Обтегач / Turnbuckles hook & eye / Distantier intindere

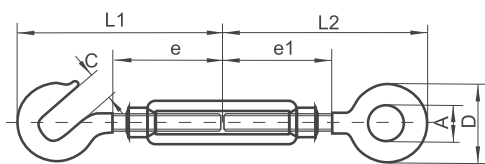

art. N	size	box	ctn
521501	6mm	20	400
521502	8mm	-	250
521503	10mm	5	100
521504	12mm	10	100
521505	16mm	3	30

Арт. N	дължина на обтягане	размер мм	L1 мм	L2 мм	e мм	e1 мм	A мм	C мм	D мм	единично тегло кг	товароподемност кг
521501	215	M6	55	55	35	35	8	5	16	0.128	100
521502	280	M8	90	90	60	60	12	8	26	0.192	200
521503	325	M10	115	100	70	70	15	12	32	0.288	300
521504	430	M12	145	130	90	90	16	14	35	0.512	500
521505	540	M16	185	170	120	120	22	20	45	1.150	1000

Кыка / Light hook / Carlig simplu

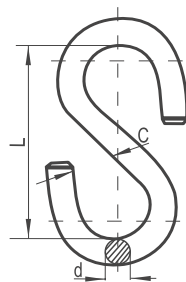

art. N	size	box	ctn
521301	3mm	50	5000
521302	4mm	30	3000
521303	5mm	30	1500
521304	6mm	20	1000
521305	7mm	10	500
521306	8mm	8	400

Арт. N	диаметър на тялото d mm	височина L mm	ширина на отвора C mm	тегло 100 бр. кг
521301	3	19	6	0.31
521302	4	27	8	0.88
521303	5	35	9	1.06
521304	6	43	10	4.66
521305	7	51	17	6.00
521306	8	59	20	6.75



Анкер сегментен / Wedge anchor / Conespand

511901	6x60mm	4	1000
511929	6x70mm	4	1000
511902	6x80mm	4	1000
511903	6x90mm	4	1000
511904	8x60mm	4	1000
511905	8x80mm	4	800
511906	8x100mm	4	600
511931	8x120mm	4	400
511907	8x140mm	4	400
511932	8x160mm	4	320
511908	10x60mm	4	500
511909	10x80mm	4	500
511930	10x90mm	-	320
511910	10x100mm	4	400
511911	10x120mm	4	400
511912	10x140mm	4	300
511913	10x160mm	10	250

art. №	size	box	ctn
511914	10x180mm	10	200
511915	10x200mm	10	200
511916	10x220mm	10	200
511917	12x80mm	4	400
511918	12x90mm	4	300
511919	12x100mm	4	300
511920	12x120mm	10	250
511921	12x140mm	4	200
511922	12x160mm	10	200
511923	12x180mm	10	200
511924	12x200mm	10	150
511925	16x80mm	10	150
511926	16x100mm	10	150
511927	16x120mm	10	150
511928	16x140mm	10	100



арт. N	размер	d мм	дължина на резбата мм	дълбочина на отвора мм	l мм	сила на затягане кН.м	сила на издърпване кг
511901	6 x 60	6	25	35	60	1.5	800
511929	6 x 70	6	25	35	70	1.5	800
511902	6 x 80	6	25	35	80	1.5	800
511903	6 x 90	6	35	35	90	1.5	800
511904	8 x 60	8	25	40	60	3.0	800
511905	8 x 80	8	25	40	80	3.0	1100
511906	8 x 100	8	25	40	100	3.0	1100
511931	8 x 120	8	25	40	120	3.0	1100
511907	8 x 140	8	25	40	140	3.0	1100
511932	8 x 160	8	25	40	160	3.0	1100
511908	10 x 60	10	30	40	60	3.0	1100
511909	10 x 80	10	30	50	80	3.0	1100
511930	10 x 90	10	30	50	90	4.0	1450
511910	10 x 100	10	30	50	100	4.0	1450
511911	10 x 120	10	30	50	120	4.0	1450
511912	10 x 140	10	30	50	140	4.0	1450
511913	10 x 160	10	30	50	160	4.0	1450
511914	10 x 180	10	30	50	180	4.0	1450
511915	10 x 200	10	30	50	200	4.0	1450
511916	10 x 220	10	30	50	220	4.0	1450
511917	12 x 80	12	40	50	80	5.5	2250
511918	12 x 90	12	40	50	90	5.5	2250
511919	12 x 100	12	40	60	100	5.5	2250
511920	12 x 120	12	40	60	120	5.5	2250
511921	12 x 140	12	40	60	140	5.5	2250
511922	12 x 160	12	40	60	160	5.5	2250
511923	12 x 180	12	40	60	180	5.5	2250
511924	12 x 200	12	40	60	200	5.5	2250
511925	16 x 80	16	60	70	80	10.3	2250
511926	16 x 100	16	60	70	100	10.3	3350
511927	16 x 120	16	60	80	120	10.3	3350
511928	16 x 140	16	60	80	140	10.3	3350

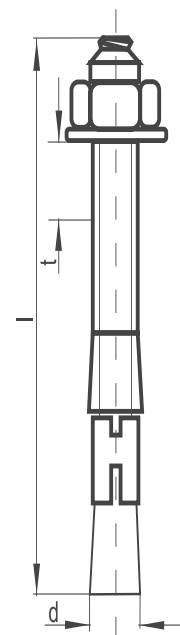



Анкер за набиване / Drop in anchor / Conespond ingopat

art. N	size	box	ctn
512101	6mm	40	4000
512102	8mm	20	2000
512103	10mm	20	1000
512104	12mm	10	500
512106**	20mm	4	100

**Трайно намалена цена / Sale price / Pret de vanzare

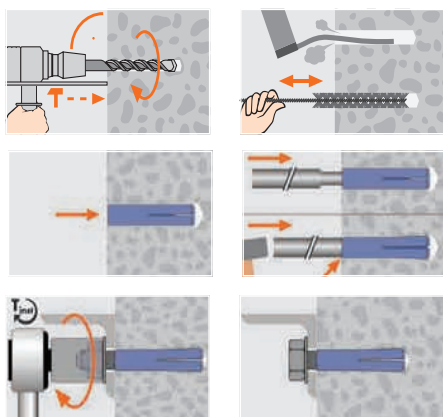
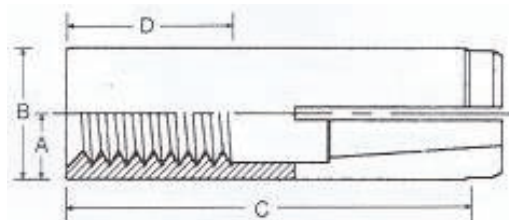
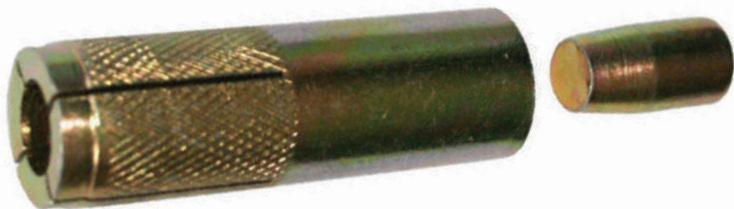

Арт. N	втр. резба (A)	р-р дюбела и свредлото мм (B)	дължина на резбата мм (D)	дълбочина на отвора мм (C)
512101	M6 (W1/4)	8.0	10	25
512102	M8 (W5/16)	10.0	14	30
512103	M10 (W3/8)	12.0	15	40
512104	M12 (W1/2)	16.0	20	50
512105	M16 (W5/8)	20.0	25	65
512106	M20 (W3/4)	25.0	35	80

Анкер-пирон за окачен таван / Ceiling anchor / Ancora tavan



art. N	∅	Length	box	ctn
512201	6mm	35mm	20	2000

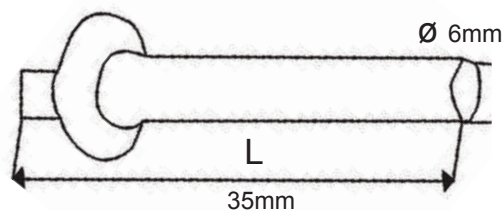

Скоба за телеф. кабел, плик / Cable clip, bag / Clipsuri plastic, set



art. N	size	бр. в плик/ bag	ctn
519908	4mm	100	-
519909	5mm	100	-
519910	6mm	100	300
519911	7mm	100	300
519912	8mm	100	200
519913	10mm	70	200



Нум, пук 50бр. / Blind rivet, 50pcs bag / Pop-nituri, set 50 buc

art. №	size (D1 x L)	сила на издърпв. N	сила на затягане N	pcs in bag	box	ctn
511132	3x8mm	620	810	50	20	320
511133	3x10mm	620	810	50	20	320
511134	3x12mm	620	810	50	20	320
511135	4x 8mm	1200	1600	50	20	200
511136	4x10mm	1200	1600	50	20	200
511137	4x12mm	1200	1600	50	20	200
511138	4x14mm	1200	1600	50	20	200
511139	4x16mm	1200	1600	50	20	200
511140	5x 8 mm	2000	2500	50	20	200
511141	5x10 mm	2000	2500	50	20	160
511142	5x12 mm	2000	2500	50	20	160
511143	5x14 mm	2000	2500	50	20	160
511144	5x16 mm	2000	2500	50	20	160
511145	5x19 mm	2000	2500	50	20	120
511146	5x25 mm	2000	2500	50	20	100

1. тяло AlMg 3/3,5 / Aluminium ALMg 3/3.5
2. пирон стомана / Steel zinc plated

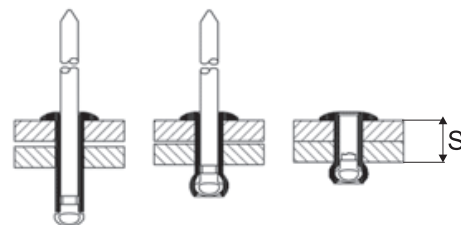
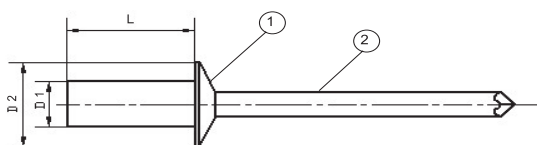

Нум, кумия / Blind rivet, box / Pop-nituri, cutie

art. №	size (D1 x L)	сила на издърпв. N	сила на затягане N	box кутия	ctn
511101	3x 8mm	620	810	1000	20
511103	3x10mm	620	810	1000	20
511105	3x12mm	620	810	1000	20
511107	4x 8mm	1200	1600	1000	20
511109	4x10mm	1200	1600	1000	20
511112	4x12mm	1200	1600	1000	20
511114	4x14mm	1200	1600	500	20
511116	4x16mm	1200	1600	500	20
511118	5x 8mm	2000	2500	500	20
511120	5x10mm	2000	2500	500	20
511122	5x12mm	2000	2500	500	20
511124	5x14mm	2000	2500	500	20
511126	5x16mm	2000	2500	500	20
511128	5x19mm	2000	2500	500	20
511130	5x25mm	2000	2500	250	20

1. тяло AlMg 3/3,5 / Aluminium ALMg 3/3.5
2. пирон стомана / Steel zinc plated

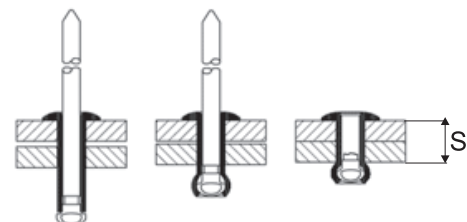
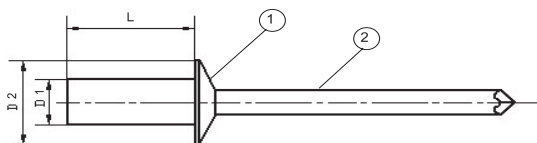

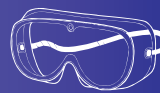

Очила прегпазни / Safety goggles / Ochelari de protectie



EN 166

art. N	size	box	ctn
560801	-	-	200

- Визьор - безцветен поликарбонат
- Рамка - PVC
- Удобна лента за глава

- Visor - colourless polycarbonate
- Frame - PVC
- Comfortable headband

- Vizor-plicarbonat incolor
- Rama-PVC
- Banda de sustinere confortbila



Очила прегпазни олекотени / Safety goggles / Ochelari de protectie



EN 166

art. N	size	box	ctn
560802	-	20	240

- Визьор - безцветен поликарбонат
- Пластмасова рамка

- Visor - colourless polycarbonate
- Plastic frame

- Vizor-plicarbonat incolor
- Rama plastic



К-т маска за прах и защитни очила / 2pcs set, Dust mask and safety goggles / Set ochelari de protectie, masca praf



EN 149
EN 166

art. N	size	box	ctn
561101	-	-	100

- Визьор - безцветен поликарбонат.
- Рамка - PVC; Удобна лента за глава.
- Респиратор FFP1 - Защита от нетоксични твърди частици и течни аерозоли.

- Visor - colourless polycarbonate.
- Frame - PVC; Comfortable headband
- Respirator FFP1- protection against non-toxic particles and aqueous aerosols

- Vizor-plicarbonat incolor.
- Rama-PVC; Banda de sustinere confortbila.
- Masca de protectie respiratorie FFP1-protectie impotriva particulelor non-toxice si aerosoli.



К-т маска за прах, защитни очила и антифон / 3 pcs set, Dust mask, safety goggles and earmuff / Set ochelari de protectie, masca praf, casti antifonice



EN 166
EN 149
EN 352

art. N	size	box	ctn
561102	-	-	50

- Визьор - безцветен поликарбонат.
- Рамка - PVC; Удобна лента за глава.
- Пластмасов мидообразен предпазител за слуха.
- Респиратор FFP1 - Защита от нетоксични твърди частици и течни аерозоли.

- Visor - colourless polycarbonate.
- Frame - PVC; Comfortable headband
- Plastic shell ear-protector.
- Respirator FFP1- protection against non-toxic particles and aqueous aerosols.

- Vizor - plicarbonat incolor.
- Rama-PVC; Banda de sustinere confortbila
- Casca protectie urechi.
- Masca de protectie respiratorie FFP1-protectie impotriva particulelor non-toxice si aerosoli.



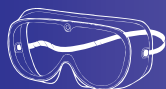

Прегпазна каска / Safety helmet / Caska de protectie

art. N	size	box	ctn
560901	-	-	40

- Материал на корпуса - PE.
- PVC околоожка с четири-точково закрепване.
- Устойчива на ел. напрежение до 220V.
- Възможност за поставяне на антифон.
- Тегло: 323g.
- Light polyethylene shell hanged on PVC belts in 4 points.
- Electrical resistance up to 220V.
- Allows wearing earmuffs.
- Total weight 323g.
- Casca protectie prinsa in 4 puncte cu benzi din PVC.
- Pentru lucrul in siguranta la tesiuni de 220V.
- Permite purtarea casti antifonice.
- Greutate totala 323g.

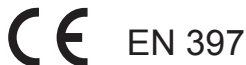

Маска за заваряване с околоожка / Welding helmet / Maska de sudura

art. N	size	box	ctn
560910	-	-	25

- Материал на корпуса - PP, подвижен екран.
- Филтър Nr. 10
- Shell - PP, movable screen
- Filter Nr. 10
- Carcasa -PP, ecran mobil
- Filtru Nr.10



Ръкавици топени в полиуретан / Gloves PU / Manusi poliuretan

art. №	size	color	box	ctn
555102*	10	white	20	240
555105*	10	black	20	240

- Топени в полиуретан. Фино безшевено полиестерно трико. Дишащ гръб. Ластичен маншет. Антистатични. Подходящи за прецизна работа с дребни елементи. Размер 10.
- Poliuretan coated palm and fingers. Fine sutureless polyester tricot. Elastic wristband. Antistatic. Suitable for precision work with small particles. Size 10.
- Material de acoperire pentru palma si degete: poliuretan. Suport: Tricot. Manseta elastica. Antistatica. Potrivite pentru lucrul cu obiecte mici. Marime 10.

EN 420, EN 388

Art. № 555102



Art. № 555105



*опаковка - индивидуален плик

Ръкавици нитрилна промазка, твърд маншет / Blue nitrile fully coated gloves, safety lining / Manusi de lucru, nitril albastre

art. N	size	box	ctn
130125	10	10	120

- Изцяло топени в нитрил. Маслоустойчиви. Безшевено трико. Подсилена длан. Твърд маншет. Размер 10.
- Fully nitrile coated. Resistant to industrial oils. Sutureless tricot. Reinforced palm. Hard wristband. Size 10.
- Material de acoperire pentru palma si degete: nitril. Rezistente la uleiuri industriale. Suport: Tricot. Palma ranforsata. Manseta rigida. Marime 10.

EN 420, EN 388



*опаковка - картонен хенгер

COMING SOON



Ръкавици нитрилна промазка, ластичен маншет / Blue nitrile fully coated, jersey lining / Manusi de lucru, nitril albastre cu elastic



EN 420, EN 388

art. N	size	box	ctn
130124	10	10	120

- Изцяло топени в нитрил. Маслоустойчиви. Безшевно трико. Ластичен маншет. Размер 10.
- Fully nitrile coated. Resistant to industrial oils. Sutureless tricot. Elastic wristband. Size 10.
- Material de acoperire pentru palma si degete: nitril. Rezistente la uleiuri industriale. Suport: Tricot. Manseta elastica. Marime 10.

Ръкавици бяло трико, топени в нитрил / Working gloves, nitrile coated, blue / Manusi de lucru, nitril albastre



EN 420, EN 388

art. N	weight	size	box	ctn
540137	60g	10	10	120

- Топени в нитрил. Дишащ гръб. Безшевно трико. Ластичен маншет. Размер 10.
- Nitril coated, open back. Sutureless tricot. Elastic wristband. Size 10.
- Material de acoperire pentru palma si degete: nitril. Suport: Tricot. Manseta elastica. Marime 10.

Ръкавици, топени в нитрил, оранжеви / Working gloves, nitrile coated, orange / Manusi de lucru nitril portocalii



EN 420, EN 388

art. N	weight	size	box	ctn
540110	40g	10	10	120

- Топени в нитрил. Безшевно трико. Ластичен маншет. Размер 10.
- Nitril coated. Sutureless tricot. Elastic wristband. Size 10.
- Material de acoperire pentru palma si degete: nitril. Suport: Tricot. Manseta elastica. Marime 10.

Ръкавици бяло трико / жълт нитрил / Working gloves, nitrile coated, yellow / Manusi de lucru, nitril galbene



EN 420, EN 388

art. N	weight	size	box	ctn
540111	60g	10	10	120

- Топени в нитрил. Дишащ гръб. Безшевно трико. Ластичен маншет. Размер 10.
- Nitril coated, open back. Sutureless tricot. Elastic wristband. Size 10.
- Material de acoperire pentru palma si degete: nitril. Suport: Tricot. Manseta elastica. Marime 10.

Ръкавици сиво трико / сив нитрил / Grey base, grey nitrile coated gloves / Manusi de lucru, nitril gri



Art. No: 554001

EN 420, EN 388

art. N	size	box	ctn
540139	10	20	240
554001*	10	20	240

- * опаковка - картонен хенгер
- Топени в нитрил. Дишащ гръб. Безшевно полиестерно трико. Ластичен маншет. Размер 10.
- Nitril coated, open back. Sutureless polyester tricot. Elastic wristband. Size 10.
- Material de acoperire pentru palma si degete: nitril. Suport: Tricot poliester. Manseta elastica. Marime 10.



Ръкавици синьо трико / черен нитрил / Blue base, black nitrile coated gloves / Manusi de lucru, poliester albastru/ nitril negru

art. N	size	box	ctn
554003	10	20	240

- Топени в нитрил. Дишащ гръб. Безшевно полиестерно трико. Ластичен маншет.
- Размер 10.
- Nitril coated, open back. Sutureless polyester tricot. Elastic wristband. Size 10.
- Material de acoperire pentru palma si degete: nitril. Suport: Tricot poliester. Manseta elastica. Marime 10.

EN 420, EN 388



Ръкавици сиво трико / сив латекс / Grey brushed base, grey latex coated gloves / Manusi de lucru cauciucate gri

art. N	size	box	ctn
540133	10	10	120
540134*	10	10	120

* опаковка картонен хенгер

- Топени в латекс. Безшевно плетено трико. Дишащ гръб. Ластичен маншет. Размер 10.
- Latex coated, open back. Sutureless knitted tricot. Elastic wristband. Size 10.
- Material de acoperire pentru palma si degete: nitril. Suport: Tricot poliester. Manseta elastica. Marime 10.

EN 420, EN 388



Art. No: 540134

Ръкавици сиво трико / сив латекс ЕКО / Grey base, grey latex coated gloves ECO / Manusi de lucru cauciucate gri ECO

art. N	size	box	ctn
540140	10	10	120

- Топени в латекс. Безшевно плетено трико. Дишащ гръб. Ластичен маншет. Размер 10.
- Latex coated, open back. Sutureless knitted tricot. Elastic wristband. Size 10.
- Material de acoperire pentru palma si degete: Latex. Suport: Tricot. Manseta elastica. Marime 10.

EN 420, EN 388



*опаковка - индивидуален плик

Ръкавици червено трико / черен латекс / Red base, black latex coated gloves / Manusi de lucru poliester rosu / latex negru

art. N	size	box	ctn
540138	10	20	240

- Топени в латекс. Дишащ гръб. Безшевно полиестерно трико. Ластичен маншет.
- Размер 10.
- Latex coated, open back. Sutureless polyester tricot. Elastic wristband. Size 10.
- Material de acoperire pentru palma si degete: Latex. Suport: Tricot poliester. Manseta elastica. Marime 10.

EN 420, EN 388



*опаковка - индивидуален плик



Ръкавици, памучни с гума / Yellow rubber gloves, cotton inner base / Manusi de lucru galbene cauciucate



art. N	size	box	ctn
130127	10	10	120

- Безшевено памучно трико и гума. Дишащ гръб. Ластичен маншет. Размер 10.
- Sutureless cotton base. Rubber covered. Open back. Elastic wristband. Size 10.
- Material de acoperire pentru palma si degete: Cauciuc. Suport: Tricot bumbac. Manseta elastica. Marime 10.

EN 420, EN 388

Ръкавици, памучни с гумена длан / Cotton white base, red rubber palm gloves / Manusi de lucru rosii cauciucate



art. N	size	box	ctn
130128	10	10	120

- Безшевено памучно трико. Гумена длан, релефна. Ластичен маншет. Размер 10.
- Sutureless cotton base. Embossed rubber palm and fingers. Elastic wristband. Size 10.
- Material de acoperire pentru palma si degete: Cauciuc. Suport: Tricot bumbac. Manseta elastica. Marime 10.

EN 420, EN 388

Ръкавици градински полиестерно трико / нитрил / Garden gloves, nitrile coated / Manusi pentru gradinarit nitril



art. N	size	box	ctn
554002	10	20	240

- Топени в полиуретан. Дишащ гръб. Безшевено полиестерно трико. Ластичен маншет. Размер 10.
- Nitril coated. open back. Sutureless polyester tricot. Elastic wristband. Size 10.
- Material de acoperire pentru palma si degete: ru.
- Suport: Tricot poliester. Manseta elastica. Marime 10.

EN 420, EN 388

Ръкавици домакински "BASIC" / Household gloves "BASIC" / Manusi gospodarie "BASIC"



art. N	size	box	ctn
554300	S	20	240
554301	M	20	240
554302	L	20	240
554303	XL	20	240

- Материал: латекс. Плътност; 0.40mm. Дължина 320mm.
- Material: latex. Thickness: 0.40mm. Length: 320mm.
- Material: latex. Grosime: 0.40 mm. Lungime: 320mm.

EN 1186

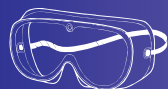

Жилетка светлоотразителна / High Visibility Waistcoat / Vesta reflectorizanta

art. N	size	box	ctn
130113	XL	10	100
130114	XL	10	100

- материал: 100% полиестер
- material: 100% polyester

EN 471

130113



130114



Дъждобран с качулка / Raincoat with hood / Pelerina de ploaie cu gluga

art. N	size	box	ctn
130205	XL	-	25
130206	XXL	-	25
130207	XXXL	-	25

- Материал: PVC.;
- Плътност: 0.20 mm.;
- Цвят: зелен.
- Material: PVC.
- Thickness: 0.20mm.
- Color: green.
- Material: PVC.
- Grosime: culoare 0.20mm.
- Culoare: verde.

EN 340



Дъждобран с качулка / Raincoat with hood / Pelerina de ploaie cu gluga

art. N	size	box	ctn
550202	XL	-	25
550203	XXL	-	25
550204	XXXL	-	25

- Материал: PVC.;
- Плътност: 0.15 mm.;
- Цвят: зелен.
- Material: PVC.
- Thickness: 0.15 mm.
- Color: green.
- Material: PVC.
- Grosime: culoare 0.15 mm.
- Culoare: verde.

EN 340



Работен гащеризон / Working coveralls / Combinezon de lucru

art. N	size	box	ctn
130154	XXL	-	10
130155	XXXL	-	10

- 80% полиестер, 20% памук.
- Обемни джобове.
- 80% polyester, 20% cotton
- 80% poliester, 20% bumbac



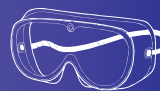

Работен полузащеризон / Working bibpants / Pantalon cu pieptar



art. N	size	box	ctn
130194	S	-	10
130156	M	-	10
130157	L	-	10
130158	XL	-	10
130159	XXL	-	10
130160	XXXL	-	10

- 80% полиестер, 20% памук
- Обемни джобове
- 80% polyester, 20% cotton
- 80% poliester, 20% bumbac

Работно яке / Working jacket / Haina de lucru



art. N	size	box	ctn
130172	L	-	10
130173	XL	-	10

- 80% полиестер, 20% памук.
- Обемни джобове.
- 80% polyester, 20% cotton
- 80% poliester, 20% bumbac

Работен елек / Working vest / Vesta de lucru



art. N	size	box	ctn
130161	M	-	10
130162	L	-	10
130165	XXXL	-	10

- 80% полиестер, 20% памук
- Обемни джобове
- 80% polyester, 20% cotton
- 80% poliester, 20% bumbac

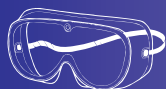

Работен панталон / Working pants/ Pantaloni de lucru

art. N	size	box	ctn
130123	S	-	10
130166	M	-	10
130167	L	-	10
130168	XL	-	10
130169	XXL	-	10
130170	XXXL	-	10

- Материал: 80% полиестер, 20% памук
- Обемни джобове
- 80% polyester, 20% cotton
- 80% poliester, 20% bumbac



Работно яке EMERTON / Working jacket EMERTON / Haina de lucru EMERTON

art. N	size	box	ctn
550315	XL	-	20
550316	XXL	-	20

- 80% полиестер, 20% памук, подсилени лакти, обемни джобове, свалящи се ръкави.
- 80% polyester, 20% cotton, reinforcement, removable sleeves.
- 80% poliester, 20% bumbac, reinforcement, mâneci detaşabile.



Работен панталон EMERTON / Working pants EMERTON / Pantaloni de lucru EMERTON

art. N	size	box	ctn
550307	M	-	20
550308	L	-	20
550309	XL	-	20

- 80% полиестер, 20% памук, подсилени колена
- Обемни джобове
- 80% polyester, 20% cotton, reinforcement
- 80% poliester, 20% bumbac, reinforcement



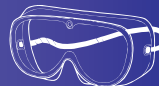

Работни обувки SHO 001 / Working shoes SHO 001 / Pantofi de protectie SHO 001



art. N	size	box	ctn
130135	40	-	10
130136	41	-	10
130137	42	-	10
130138	43	-	10
130139	44	-	10
130140	45	-	10
130141	46	-	10

- Категория S1P. Естествена телешка кожа; Метално бомбе (200J, 15kN); Антистатични;
- Поглъщане на енергията в областта на ходилото. Устойчиви срещу прободане от твърди предмети (метална пластина в ходилото); Антивибрационни; Маслоустойчиви; Противохлъзгащо полиуретаново ходило.
- Category S1P. Metal toe-cap (resistant up to 200J, 15kN); Anti-static; Shock and vibration absorbant; Cut resistant; Water resistance; Oil resistant; Slippingproof.
- Categoria S1P. Bombeu metalic (rezistent pana la 200J, 15kN). Talpa antisoc, anti statica, rezistenta la taiere rezistente la apa, rezistent la ulei, antialunecare.

EN ISO 20345:2005

Работни обувки SHO 002 / Working shoes SHO 002 / Pantofi de protectie SHO 002



art. N	size	box	ctn
130186	40	-	10
130187	41	-	10
130188	42	-	10
130189	43	-	10
130190	44	-	10
130191	45	-	10
130192	46	-	10

- Категория S1P. Естествена телешка кожа; Метално бомбе (200J, 15kN); Антистатични;
- Поглъщане на енергията в областта на ходилото. Устойчиви срещу прободане от твърди предмети (метална пластина в ходилото); Антивибрационни; Маслоустойчиви; Противохлъзгащо полиуретаново ходило.
- Category S1P. Metal toe-cap (resistant up to 200J, 15kN); Anti-static; Shock and vibration absorbant; Cut resistant; Water resistance; Oil resistant; Slippingproof.
- Categoria S1P. Bombeu metalic (rezistent pana la 200J, 15kN). Talpa antisoc, anti statica, rezistenta la taiere rezistente la apa, rezistent la ulei, antialunecare.

EN ISO 20345:2005

Ботуши PVC, 38cm, черни / PVC boots, 38cm, black / Cizme cauciuc, 38cm, negru



art. N	size	box	ctn
550405	40	-	10
550406	41	-	10
550407	42	-	10
550408	43	-	10
550409	44	-	10
550410	45	-	10
550411	46	-	10

- Антистатични в зоната на петата. Дълбок грайфер.
- Подметка устойчива на течни масла.
- Дължина 38cm
- Shock absorption in the zone of the heel.
- Industrial oil and fuel resistant. Deep gripple.
- Length 38cm.
- Amortizor de socuri in zona calcaiului.
- Rezistent la uleiuri si combustibili industriali. Aderenta mare.
- Lungime 38cm.

EN 347, EN 344

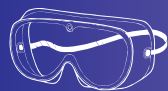

Ботушу PVC, 28cm, черни / PVC Boots, 28cm, black colour / Cizme din PVC, 28 cm, negru

art. N	size	box	ctn
550481	40	-	10
550482	41	-	10
550483	42	-	10
550484	43	-	10
550485	44	-	10
550486	45	-	10

- Антистатични в зоната на петата. Дълбок грайфер.
- Подметка устойчива на течни масла.
- Дължина 28cm.
- Shock absorption in the zone of the heel.
- Industrial oil and fuel resistant. Deep gripple.
- Length 28cm.
- Amortizor de socuri in zona calcaului.
- Rezistent la uleiuri si combustibili industriali.
- Aderenta mare. Lungime 28cm



EN 347, EN 345

Таблица с общи изисквания за работни ръкавици / Table with general requirements for working gloves

		Нива на предпазване				
		1	2	3	4	5
EN 388 Механични рискове						
<u>a устойчивост на претриване</u>	<u>брой цикли</u>	≥ 100	≥ 500	≥ 2000	≥ 5000	
<u>b устойчивост на срязване</u>	<u>индекс</u>	≥ 1.2	≥ 2.5	≥ 5.0	≥ 10	≥ 20
<u>c устойчивост на раздиране</u>	<u>натоварване, N</u>	≥ 10	≥ 25	≥ 50	≥ 75	
<u>d устойчивост на перфориране</u>	<u>натоварване, N</u>	≥ 20	≥ 60	≥ 100	≥ 150	

Таблица с размери на работните облекла / Table with general sizes of working clothes

LADIES AND MANS		S	M	L	XL	XXL	XXXL
		cm	cm	cm	cm	cm	cm
ГАЩЕРИЗОН	COVERAL						
Дължина гащеризон	Length coveral	165	167.5	170	172.5	175	177.5
Дължина на ръкава	Length sleeve	57.5	59	60.5	62	63.5	65
Гръдна обиколка	Chest measurement	116	122	128	134	140	146
ПОЛУГАЩЕРИЗОН	VIBPANT						
Дължина полугащ.	Lenght bibpant	108	109	110	111	112	113
Талия	Waist	78	84	90	96	102	108
Ханш	Haunch	104	110	106	122	128	134
ЯКЕ	JACKET						
Дължина яке	Length jacket	72	74	76	78	80	82
Дължина на ръкава	Length sleeve	83	85.5	88	90.5	93	95.5
Гръдна обиколка	Chest measurement	118	124	130	136	142	148
ПАНТАЛОН	PANT						
Дължина панталон	Length pant	110	111	112	113	114	115
Талия	Waist	78	84	90	96	102	108
Ханш	Haunch	106	112	118	124	130	136



TopGarden



Марката **TopGarden** е наложена на българския пазар през 2005 година и до днес се е утвърдила с продуктите си, доброто качество, ергономичен дизайн и приятна естетика.

Благодарение на вас ние разширявахме гамата си продукти ежегодно, за да ви осигурим максимално разнообразие. То в комбинация с нашата постоянна професионална подкрепа е пътят към вашата удовлетвореност.

The **TopGarden** brand has been present on Bulgarian market since 2005 and up to the present has strengthened its positions with the good quality, ergonomic design and pleasant aesthetics.

You are the people to whom we owe the expansion of our portfolio annually with the purpose to provide you with maximum diversity. This, combined with our constant professional support is the way to your satisfaction.

Brandul **TopGarden** este prezent pe piata din Bulgaria inca din 2005, consolidandu-si pozitia cu produsele sale de buna calitate, design ergonomic si estetica placuta.

Ne simtim obligati fata de dvs. pentru a ne mari portofoliul anual, cu scopul de a va furniza diversitate maxima. Aduagand sprijinul profesional, consideram ca astfel va aducem satisfactia.



Конектор за маркуч / Plastic hose connector / Mufa inadire furtun

art. N	size	box	ctn
380954	1/2"	1	120
380955	3/4"	1	120

- Конекторът се сменя с леко издърпване
- Connector is changed slightly pulling
- Conector este schimbat ușor trăgând



Конектор за маркуч със стоп / Plastic hose connector with stop / Mufa cu stop

art. N	size	box	ctn
380933	1/2"	1	120
380956	3/4"	1	120

- Конекторът се сменя с леко издърпване
- При разделение автоматично спира притока на вода
- Connector is changed by slightly pulling out
- In division automatically stops water flow
- Conector este schimbat ușor trăgând
- În diviziunea se oprește automat debitul de apă



Конектор за маркуч с резба / Female hose connector / Mufa inadire furtun

art. N	size	box	ctn
380934	1/2"	1	120

- Приставка с вътрешна резба
- Conector with internal thread
- Plug cu filet intern



Съединител за маркуч / Hose mender / Mufa inadire furtun

art. N	size	box	ctn
380936	1/2" x 1/2"	1	120
380957	3/4" x 3/4"	1	120

- Материал ABS
- Plastic ABS
- Plastic ABS





Разклонител за конектори 2-посочен / 2 Way hose coupling / Prelungitor furtun



art. N	size	box	ctn
380959	1/2"	1	120

- За използване на два канала за подаване на вода
- Two channels for the water supply
- Două canale pentru alimentarea cu apă

Разклонител за конектори 3-посочен / 3 Way hose coupling / Adaptor cu 3 cai



art. N	size	box	ctn
380971	1/2"	1	250

- За използване на три канала за подаване на вода
- Three channels for the water supply
- Trei canale pentru alimentarea cu apă

Разклонител 4 изхода със стоп / Hose connector 4 way with stop / Conector furtun 4 cai cu stop



art. N	size	box	ctn
380973	1/2"-3/4"	1	24

- Възможност за използване на 4 различни градински маркуча без смяна на адаптора.
- Всеки маркуч може да се ползва независимо от останалите.
- For use of 4 different hoses without changing the adaptor.
- Each hose can be used separately from the others.
- Pentru utilizarea a 4 furtunuri diferite fara a schimba adaptorul.
- Fiecare furtun poate fii utilizat separat.

Разклонител 2 изхода със стоп / Hose connector 2 way with stop / Conector furtun 2 cai cu stop

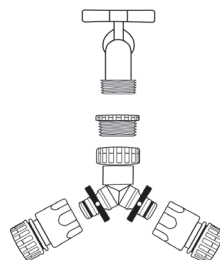

art. N	size	box	ctn
380974	1/2"-3/4"	1	250

- Възможност за използване на 2 различни градински маркуча без смяна на адаптора.
- Всеки маркуч може да се ползва независимо от останалите.
- For use of 2 different hoses without changing the adaptor.
- Each hose can be used separately from the others.
- Pentru utilizarea a 2 furtunuri diferite fara a schimba adaptorul.
- Fiecare furtun poate fii utilizat separat.

Аганмор за кран / Plastic tap adaptor / Mufa ptr robinet

art. N	size	box	ctn
380952	1/2"-3/4"	1	120
380972	1/2"-3/4"-1"	1	100

- За кранове, които са на резба
- For taps, which are threaded
- Pentru macarale, care sunt filetate

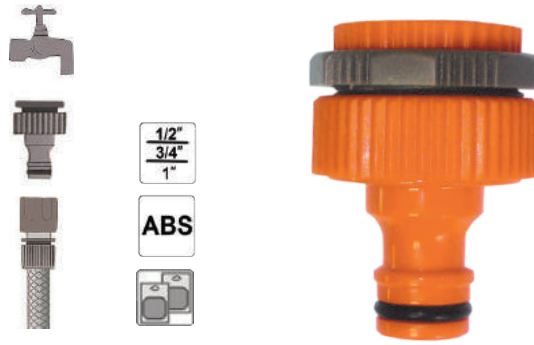

Аганмор за кран със скоба / Tap adaptor / Mufa ptr robinet cu filet

art. N	size	box	ctn
380953	1/2"-3/4"	1	120

- За кранове, които не са на резба
- Устойчив на корозия, лесно поставяне
- For taps, which are not threaded
- Corrosion resistant, easy placement
- Pentru macarale, care nu sunt filetate
- Rezistente la coroziune, ușor de plasament

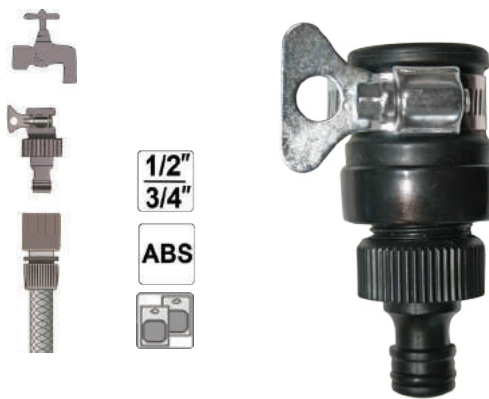

Разпръсквач осцилиращ 16 гюзу / 16 Hole oscillating sprinkler / Aspersor oscilant 16 orificii

art. N	box	ctn
380949	1	12

- Главно регулиране на разпръскването до 20м
- За поливане на различни по размер правоъгълни площи
- Smooth adjustment of the dispersion up to 20 m
- For watering different sized rectangular areas
- Reglementarea Smooth de dispersie max. - 20 m
- Pentru udarea diferite domenii dimensiuni rectangulare



Разпръсквач 3-раменен ротационен с регулатор / Adjustable 3-arm sprinkler w/h base / Aspersor ajustabil cu 3 brate

art. N	box	ctn
380946	6	72

- Обхват на разпръскването до 18м
- Възможност за свързване с друг разпръсквач
- Стабилна основа, регулиране на дюзите
- Range of dispersion up to 18m
- Possibility to connect to another sprinkler
- Stable base, adjustable nozzles
- Gama de dispersie - max 18m
- Posibilitatea de a conecta la un alt stropitoare
- Stabil baza, reglementarea duze





Разпръсквач импулсен метален с шиш / Zinc impulse sprinkler / Aspersor cu impuls doua cai metalic

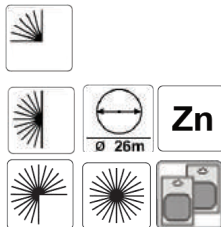

art. N	size	box	ctn
380965	1/2"	1	50

- Обхват на разпръскването до 26 м
- Регулиране посоката на разпръскване
- Diameter of spray up to 26 m
- Adjustable spreading direction
- Diametru de spray de până la 26 m
- Reglaj direcția de răspândire

Разпръсквач импулсен с шиш / Plastic impulse sprinkler / Aspersor cu impuls-1 mufa

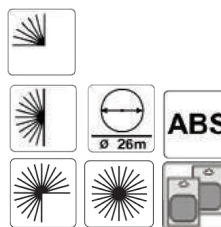

art. N	size	box	ctn
380941	1/2"	1	50

- Обхват на разпръскването до 26м
- Възможност за свързване с друг разпръсквач
- Регулиране посоката на разпръскване
- Range of dispersion up to 26m
- Possibility to connect to another sprinkler
- Adjustable spreading direction
- Gama de dispersie - max 26m
- Diametru de spray de până
- Reglaj direcția de răspândire

Разпръсквач 3-раменен с регулатор / Adjustable 3-arm sprinkler / Aspersor rotativ cu 3 brate

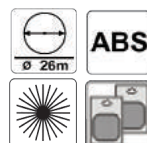

art. N	size	box	ctn
380944	1/2"	1	50

- Обхват на разпръскването до 26м
- Регулиране на дюзите.
- Възможност за свързване с друг разпръсквач
- Scope of broadcasting up to 26 m
- Adjustable nozzles
- Possibility to connect to another sprinkler
- Domeniul de aplicare al audiovizualului - 26 m
- Duze reglabile
- Posibilitatea de a conecta la un alt stropitoare

Разпръсквач 3-раменен с шиш / Plastic sprinkler 2-arm spike / Aspersor rotativ cu 3 brate

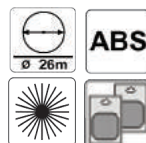

art. N	size	box	ctn
380945	1/2"	1	50

- Обхват на разпръскването до 26м
- Възможност за свързване с друг разпръсквач
- Range of dispersion up to 26m
- Possibility to connect to another sprinkler
- Gama de dispersie - max 26m
- Diametru de spray de până la 26 m



Пистолет поливен 7 функции с конектор / 2pcs set 7-pattern spray gun / 2pcs set pistol pt. stropit 7 functii cu accesorii

art. N	size	box	ctn
380969	1/2"	1	72

- Комплектът включва:
 - Пистолет със 7 режима
 - Конектор за маркуч 1/2"
 - Двуконпонентна дръжка
- The set includes:
 - 7 pattern spray gun
 - Hose connector
 - Component handle
- Include:
 - Pistol de stropit-7 functii
 - Conector furtun
 - Măner component

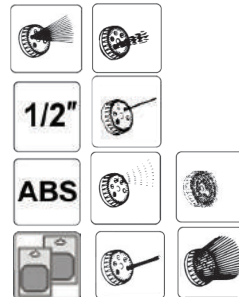

Пистолет поливен 7 функции с конектори k-m / 4pcs set 7-pattern spray gun / 4 pcs set pistol pt. stropit 7 functii cu accesorii

art. N	size	box	ctn
380924	1/2"	1	48

- Комплектът включва:
 - Пистолет със 7 режима, двуконпонентна дръжка
 - Адаптор 1/2" - 3/4"
 - Конектори за маркуч 2 бр. (1/2" със и без стоп)
- The set includes:
 - 7 pattern spray gun
 - Adaptor 1/2" - 3/4"
 - Hose connectors 2 pcs. (1/2" w/ and w/o stop button)
- Include:
 - Pistol de stropit-7 functii
 - Adaptor 1/2" - 3/4"
 - Conectori furtun 2 buc. (1/2")

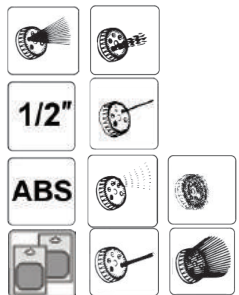

Пистолет поливен 5 функции с конектори k-m / 4pcs set 5-pattern spray gun / 4 pcs set pistol pt. stropit 5 functii cu accesorii

art. N	size	box	ctn
380970	1/2"	1	48

- Комплектът включва:
 - Пистолет с 5 режима
 - Адаптор 1/2" - 3/4";
 - Конектори за маркуч 2 бр. (1/2" със и без стоп)
- The set includes:
 - 5 pattern spray gun
 - Adaptor 1/2" - 3/4";
 - Hose connectors 2 pcs. (1/2" w/ and w/o stop button)
- Include:
 - Pistol de stropit-5 functii;
 - Adaptor 1/2" - 3/4";
 - Conectori furtun 2 buc. (1/2")





Струйник многофункционален с конектори k-m / 4pcs set adjustable nozzle / Pistol pentru stropit multifunctional cu accesorii

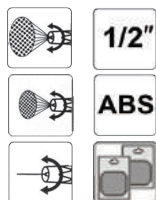

art. N	size	box	ctn
380925	1/2"	1	58

- Комплектът включва:
 - Струйник многофункционален
 - Адаптор 1/2" - 3/4"
 - Накрайници за маркуч 2 бр. (1/2" със и без стоп)
- The set includes:
 - Multy function spray nose nozzle
 - Adaptor 1/2" - 3/4" - Hose connectors 2 pcs. (1/2" w/ and w/o stop button)
- Include:
 - Pistol de stropit multifuncioal
 - Adaptor 1/2" - 3/4"
 - Conectori furtun 2 buc. (1/2")

Пистолет поливен 7 функции / 7-function nozzle / Pistol pentru stropit 7 functii

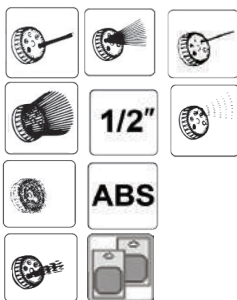
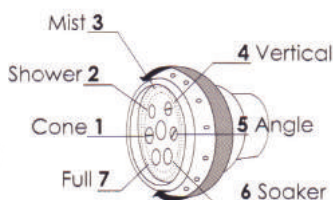

art. N	size	box	ctn
380964	1/2"	1	75

- Пистолет със седем режима на работа
- Двуконпонентна ергономична дръжка
- 7 Pattern spray gun
- Ergonomic two-component handle
- Convenabil pistol cu apă
- Pistol cu șapte moduri
- Mâner de două straturi

Пистолет поливен 5 функции / 5-function nozzle / Pistol pentru stropit 5 functii

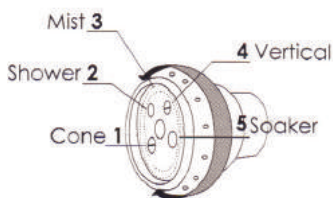

art. N	size	box	ctn
380928	1/2"	1	80

- Компактен модел с пет режима на работа
- Convenient 5 pattern spray gun
- Compact pistol cu cinci moduri



Пистолет поливен многофункционален / Adjustable spray gun / Pistol pentru stropit multifunctional

art. N	size	box	ctn
380926	1/2"	1	60

- Възможност за регулиране на водната струя - от силна струя до фина мъгла
- Двукомпонентна ергономична дръжка
- Possibility to adjust the water jet - from strong jet to fine mist
- Ergonomic two-component handle
- Posibilitatea de a ajusta cu jet de apă-un jet puternic de pulberi fine
- Mâner de două straturi

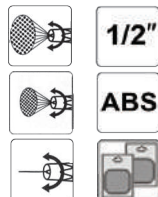

Пистолет поливен полифункционален / Adjustable spray gun / Pistol pentru stropit-multifunctional

art. N	size	box	ctn
380938	1/2"	1	80

- Възможност за регулиране на водната струя - от силна струя до фина мъгла
- Convenient model possibility to adjust the water jet - from strong jet to fine mist
- Compact pistol posibilitatea de a ajusta cu jet de apă -un jet puternic de pulberi fine

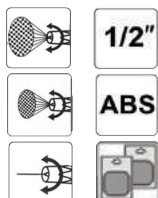

Струйник многофункционален / Adjustable nozzle gun / Pistol pentru stropit multifunctional

art. N	size	box	ctn
380927	1/2"	1	200

- Възможност за регулиране на водната струя - от силна струя до фина мъгла
- Possibility to adjust the water jet - from strong jet to fine mist
- Posibilitatea de a ajusta cu jet de apă - un jet puternic de pulberi fine





- Използвайте подходящ за вашия воден източник адаптор, за да го свържете с градински маркуч
- Use different tap adaptors to connect your water source to garden hose
- Folositi diverse adaptoare pentru robinet, daca doriti sa conectati furunul la sursa de apa

- Използването на конектори със стоп ви позволява да смените разпръсквача без разливане на вода
- Usage of water stop connector ensure safety changing of spray guns without any water waste
- Folsirea conectorilor cu stop usureaza schimbarea pistoalelor de stropit in asa fel incat sa nu se faca risipa de apa si energie

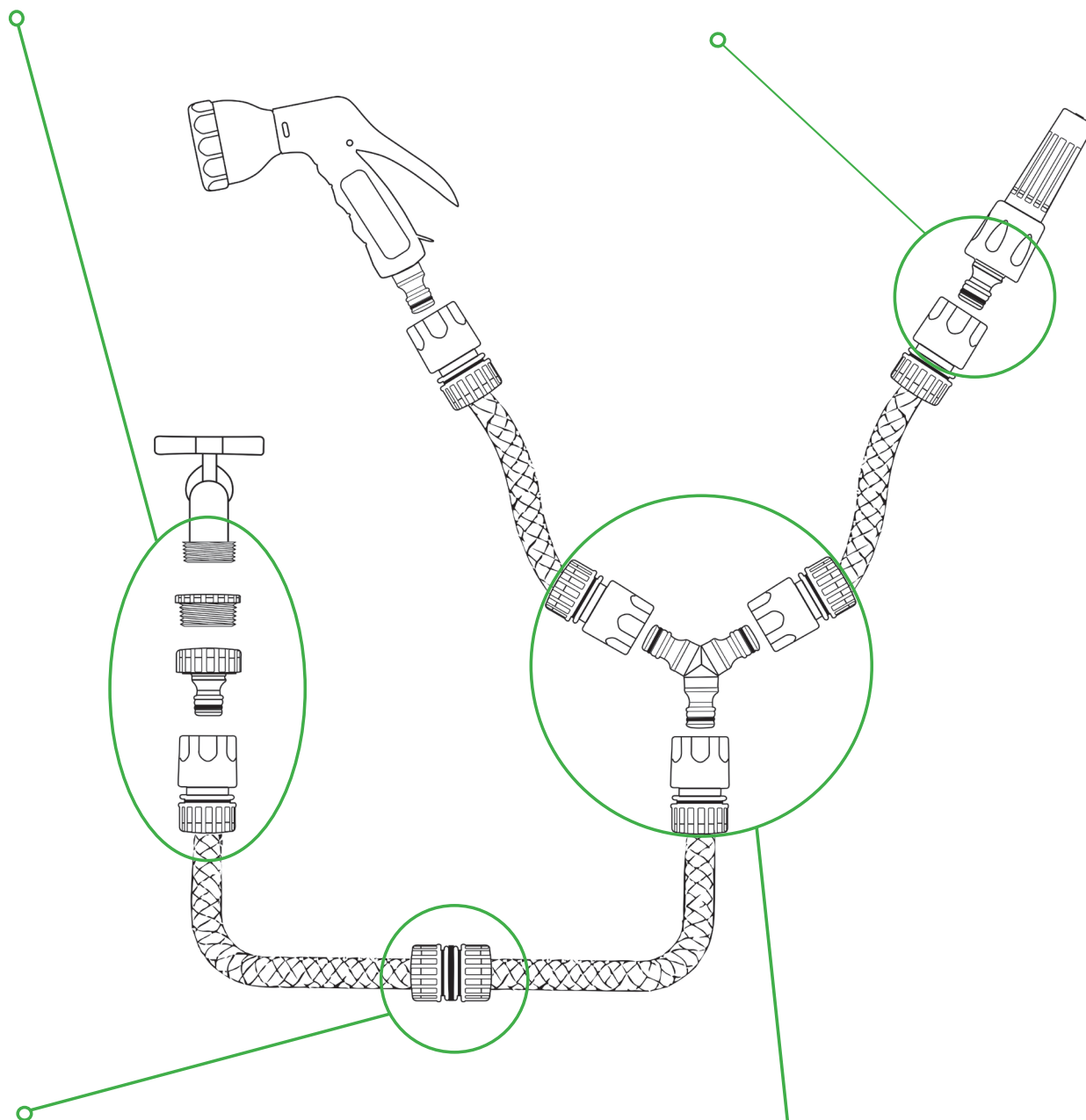

- Можете да поправите повредения маркуч без инструменти, използвайки съединител за маркуч в подходящия размер на мястото на повредата
- Hoses can be quickly and easily repaired without tools. The damaged hose part is cut out and the mender is inserted on the spot of damage
- Furtunurile pot fi reparate usor si rapid fara unelte. Partea defecta a furtunului este eliminata prin taierea si o mufa de innadire este introdusa
- pentru a uni cele doua parti ale furtunului.

- Използването на адаптори с много изходи ви осигурява възможността да работите с няколко градински маркуча и разпръсквача едновременно от един източник на вода
- Usage of many-ways adaptor provides the possibility to work with different hoses and tools from one water source
- Folosirea unor adaptoare multidirectionale, ofera posibilitatea lucrului cu furtunuri si unelte diferite la aceiasi sursa de apa



Разпръсквач "непепуга" / Butterfly Sprinkler / Aspersor decorativ fluture

art. N	size	box	ctn
380948	1/2"	1	12

- Хаотично разпръскване
- Chaotic spraying
- Haotic dispersare



Маркуч гравински / PVC tree layers garden hose / PVC Furtun de gradina

art. N	size	box
402102	1/2" - 20m	1
402105	3/4" - 25m	1
402106	1" - 50m	1

- Трислоен маркуч
- Tree layers hose
- Tree straturi de furtun

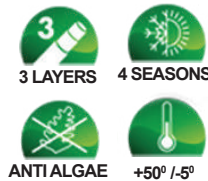

Маркуч гравински к-м с 4 бр. конектори / Garden hose with 4 pcs set / Furtun + 4 accesorii

art. N	size	box
402101	15m	1

- Комплектът включва:
 - 15 м. трислоен маркуч, 1/2"
 - Струйник ; - Адаптор 1 / 2"- 3/4"
 - Конектори за маркуч 2 бр. (1/2" със и без стоп)
- The set includes:
 - 15 m garden hose, 1/2"
 - Hose nozzle set; - Adapter 1 / 2"- 3/4"
 - Hose Connectors 2 pcs(1/2 with and without stop)
- Include:
 - 10 m furtun, 1/2"
 - Pistol de stropit-7 functii
 - Adaptor 1/2" - 3/4"
 - Conectori furtun 2 buc



Макара за маркуч к-м с маркуч и конектори / 7 functions roll hose set / Furtun + 4 accesorii

art. N	size	box	ctn
402107	15m	1	4

- Комплектът включва:
 - 15 м. трислоен маркуч, 1/2"
 - Пистолет 7 функции ; - Адаптор 1 / 2"- 3/4"
 - Конектори за маркуч 3 бр. (1/2" със и без стоп)
- The set includes:
 - 15 m garden hose, 1/2"
 - 7-function nozzle; - Adapter 1 / 2"- 3/4"
 - Hose Connectors 3 pcs(1/2 with and without stop)
- Include:
 - 15 m furtun, 1/2"
 - Pistol de stropit-7 functii
 - Adaptor 1/2" - 3/4"
 - Conectori furtun 3 buc

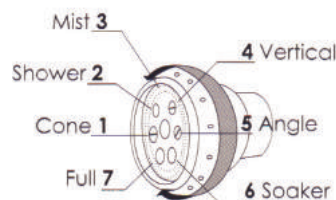



Макара за маркуч (количка) 45m / Hose reel steel tube with wheels up to 45m hose / Derulator tambur pentru furtun cadru metalic si roti 45 m



Ø 3/4"
30m

Ø 1/2"
45m

art. N	capacity	box	ctn
380966	45m-1/2"; 30m-3/4"	1	5

- Компактно съхранение
- Големи колела за лесно придвижване
- Compact storage
- Large wheels for easy movement
- Compact de depozitare
- Roti mari pentru deplasarea cu ușurință

Макара за маркуч (смоука) / Hose reel steel tube 45m hose / Derulator tambur ptr furtun cadru metalic 45 m



Ø 3/4"
30m

Ø 1/2"
45m

art. N	capacity	box	ctn
380967	45m-1/2"; 30m-3/4"	1	10

- Компактно съхранение
- Compact storage
- Compact de depozitare

Стенен държач за маркуч / Hose hanger / Suport pentru agatare furtun



1/2"

25
m

art. N	size	box	ctn
380975	25m ; 1/2"	1	100

- Възможност за окачване на маркуч и аксесоари към него
- For hanging hose and accessory
- Șanse de furtun agățat și accesorii

Пръскачка градинарска 1.5 л / Garden sprayer 1.5L / Vermorel 1.5 l



art. N	capacity(L)	box	ctn
380301	1.5	1	20

- Регулиране на водната струя - от плътна струя до фина мъгла
- Дюза от месинг
- Adjusting the water jet-stream from a strong jet to a fine mist
- Brass nozzle
- Reglementarea cu jet de apă-stream de jet puternic pentru a unei pulberi fine
- Alamă duzal



Пръскачка 20 l / Garden sprayer 20 l / Vermorel 20 l

art. N	capacity(L)	box
380310	20	1

- Възможност за регулиране на водната струя от плътна струя до фина мъгла
- Удължение от неръждаема стомана
- Комплект накрайници
- Possibility to adjust the water jet
- Stainless steel lance
- Nozzles set
- Reglementarea cu jet de apă
- Din oțel inoxidabil
- Jet reglabil



Stainless Steel



Пръскачка градинарска 16 l / Garden sprayer 16 l stainless steel extension / Vermorel 16 l extensie inox

art. N	capacity(L)	box
380314	16	1

- Възможност за регулиране на водната струя от плътна струя до фина мъгла
- Телескопично удължение от неръждаема стомана
- Комплект накрайници
- Possibility to adjust the water jet from strong jet to fine mist
- Telescopic stainless steel lance, nozzle set
- Posibilitatea de a ajusta cu jet de apă - un jet puternic de pulberi fine
- Telescopic din oțel inoxidabil, jet reglabil

65-110 cm

Stainless Steel



Пръскачка градинарска / Garden sprayer stainless steel extension / Vermorel extensie inoxl

art. N	capacity(L)	box	ctn
380315	5	1	6
380313	8	1	6

- Регулиране на водната струя - от плътна струя до фина мъгла
- Удължение от неръждаема стомана
- Adjusting the water jet-stream from a strong jet to a fine mist
- Stainless steel lance
- Reglementarea cu jet de apă-stream de jet puternic pentru a unei pulberi fine
- Lance din oțel inoxidabila

Stainless Steel





Пулверизатор с ръкохватка / Brass nozzle and steel pump with handle / Pulverizator



art. N	capacity(L)	ctn
380202	1.5-2	100

- Подходяща за използване с всички видове бутилки с високо гърло и капацитет от 1.5 до 2 L
- Suitable all types of high-necked bottles with a capacity of 1.5 to 2 L
- Potrivit pentru utilizarea cu toate tipurile de înaltă gât sticle cu o capacitate de 1,5 - 2 L

Пулверизатор / Brass nozzle and steel pump / Pulverizator



art. N	capacity(L)	ctn
380201	1.5-2	100

- Подходяща за използване с всички видове бутилки с високо гърло и капацитет от 1.5 до 2 L
- Suitable all types of high-necked bottles with a capacity of 1.5 to 2 L
- Potrivit pentru utilizarea cu toate tipurile de înaltă gât sticle cu o capacitate de 1,5 - 2 L

Угължител за пръскачка / Stainless Steel lance / Extensie otel inox



art. N	Length (cm)	box	ctn
380311	65 - 110	1	100
380312	65 - 110	1	100
410201	65 - 110	1	80

- Лек и удобен, телескопичен от неръждаема стомана
- Light and comfortable stainless steel lance
- Lumină și la îndemână, extensie otel inox

Комплект крайници за пръскачка 3 части / Set spare parts sprayers 3 pcs / Set 3 buc duze pulverizator



art. N	box	ctn
410202	1	300

- Възможност за регулиране на водната струя
- Possibility to adjust the water jet
- Reglementarea cu jet de apă

Уред за привързване / Tape tool / Aparat pentru legat plante folosind banda si capse

art. N	qty	ctn
389908	1	20
389909	10 pcs	50
389910	10 000 pcs	100
377102	1	

- Подходящ за привързване на относително леки растения към опорни колове, мрежа и въжета.
- Без загуба на лента – пести от дължината на лентата като я реже непосредствено след скобата
- Работи със скоба за прихващане и лента за привързване.
- Suitable for bonding a relatively low weight plants to stakes, netting and ropes.
- Without losing of tape - saving tape length making it cut immediately after bracket
- Works with the staples and tape.
- Potrivit pentru lipirea unei plante relativ mici de greutate la mize, plase și frânghii.
- Fără a pierde din bandă - lungime de banda de economisire site este tăiat imediat după suportul
- Funcționează cu capse și bandă.
- Potrivit pentru pomi fructiferi și viță de vie, pomi si arbusti ornamentali.



389908

Скоби за уред за привързване 10 000 бр./ кутия / Staples for tape tool 10 000pcs/box / Capse pentru legat plante

Лента за уред за привързване k-m 106p., 11.5mm x 30m / Tape for tape tool / Banda pentru legat



389910



389909

Резец за уред за привързване / Tape tool blade / Lama de rezerva pentru aparat legat cu banda



377102

Ножица за ашлагисване с три приставки / Grafting Tool / Dispozitiv pentru altoit

art. N	box	ctn
377101	1	20

- Три приставки Ω, U, V
- Омега метод ,осигуряващ висока продуктивност
- Подходяща за овошки и лозя, декоративни дървета и храсти
- Three different plugs
- Omega method ensures high productivity
- Suitable for fruit trees and vines, ornamental trees and shrubs
- Trei mufe diferite
- Metoda de Omega asigură o productivitate ridicată
- Potrivit pentru pomi fructiferi și viță de vie, pomi si arbusti ornamentali



Лента за ножица за ашлагисване / Grafting tape / Banda pentru altoit

art. N	size	box	ctn
377103	30mm x 100m	1	200





Трион с калъф / Hand saw with sheath / Ferestrau de gadina

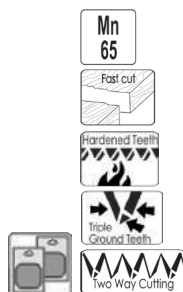

art. N	Length (mm)	ctn	
371521	270	36	

- Тристранно заточени и закалени зъби
- Двуконпонентна дръжка
- Locking mechanism
- Triangular sharpened and hardened teeth
- Bi-material handle
- Blocare
- Triunghiular ascuțit dinți căliți
- Bi-material de mâner

Трион съваем с прегназител / Saw foldable / Ferestrau de gadina pliabil

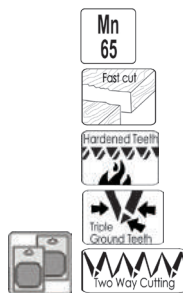

art. N	Length (mm)	box	ctn
371520	180	12	60

- Заключващ механизъм
- Тристранно заточени и закалени зъби
- Locking mechanism
- Triangular sharpened and hardened teeth
- Blocare
- Triunghiular ascuțit dinți căliți

Трион съваем с бутон / Saw foldable / Ferestrau de gadina pliabil



art. N	Length (mm)	box	ctn
371529	180	12	72

- Тристранно заточени и закалени зъби
- Двуконпонентна дръжка
- Triple sharpened and hardened teeth
- Bi-material handle
- Tripartite dinți ascuțite și întărite
- Bi-material de mâner

Трион съваем / Saw foldable / Ferestrau de gadina pliabil

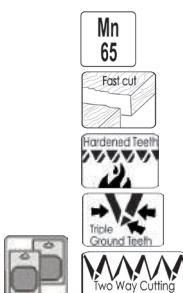

art. N	Length (mm)	box	ctn
371528	180	12	60

- Заключващ механизъм
- Тристранно заточени и закалени зъби
- Двуконпонентна дръжка
- Locking mechanism
- Triangular sharpened and hardened teeth
- Bi-material handle
- Blocare
- Triunghiular ascuțit dinți căliți
- Bi-material de mâner

Трион овошарску / Hand saw / Ferestrau de gradina

art. N	Length (mm)	box	ctn
382101	325	1	120

- Дървена дръжка
- Wooden handle
- Mâner de lemn



Ножица лозарска / Pruning shear chrome / Foarfeca pt. vie

art. N	Length (mm)	box	ctn
382305	8"/200mm	6	60
382306	10"/250mm	6	60

- Хромирано острие
- Chrome plated blade
- Chrome lama



Ножица лозарска с резерв / Pruning shear with reserve / Foarfece de gradina

art. N	Length (mm)	box	ctn
382505	9"/230	6	60

- Резервно острие (прецизно закалено) и пружина
- Усилена дръжка
- Spare blade and spring, precision tempered blade
- Reinforced handle
- Hardened handle
- Rezerva lama si primăvară, precizie temperat
- Armat mâner





Ножица за трева с въртяща глава 360° / Grass shear 360 head swivels / Foarfeca ptr. gazon 360



Stainless Steel

art. N	Length	box	ctn
371523	360°	6	48

- Удобна дръжка
- Ергономичен дизайн
- Възможност за работа с лява и дясна ръка
- Comfortable grip
- Ergonomic design
- Ability to work with left and right hand
- Prindere confortabilă
- Design ergonomic
- Capacitatea de a lucra cu mâna stânga și la dreapta

Ножица за храсти с телескопични гръжки / Pruning shear / Foarfeca gard viu r



AL



art. N	Length	box	ctn
382912	660 - 900mm	1	6

- Алюминиеви телескопични дръжки
- Острие с незалепващо покритие
- Възможност за регулиране на острието
- Light telescopic handle
- Non-stick blade coating
- Possibility to adjust the blade
- Maner telescopic
- Non-stick de acoperire lama
- Posibilitatea de a ajusta lama

Ножица за храсти с алуминиеви гръжки / Hedge shear aluminium tube / Foarfeca ptr. pomi aluminiu maner



AL



art. N	Length	box	ctn
382911	600mm	1	6

- Алюминиеви дръжки
- Острие с незалепващо покритие
- Възможност за регулиране на острието
- Aluminium handles
- Non-stick blade coating
- Possibility to adjust the blade
- Aluminium mânere
- Non-stick de acoperire lama
- Posibilitatea de a ajusta lama

Ножица за храсти с телескопична гръжка / Pruning shear / Forafeca gard viu

art. N	Length	box	ctn
382903	600 - 800mm	1	24

- Телескопична дръжката
- Удобни ръкохватки
- Telescopic handle
- Convinient handles
- Maner telescopic
- Mânere confortabile



Ножица за клони с телескопични гръжки / Anvil looper / Foarfeca pentru crengi manrere aluminiu

art. N	Length	box	ctn
382909	760 - 960 mm	1	6

- Алуминиеви телескопични дръжки
- Острие с незалепващо покритие
- Aluminium telescopic handle
- Non-stick blade coating
- Aluminiu maner telescopic
- Non-stick de acoperire blade



Ножица за клони с телескопични гръжки / Anvil looper / Foarfeca pentru crengi manrere aluminiu

art. N	Length	box	ctn
382910	510 - 710 mm	1	6

- Алуминиеви телескопични дръжки
- Острие с незалепващо покритие
- Aluminium telescopic handle
- Non-stick blade coating
- Aluminiu maner telescopic
- Non-stick de acoperire blade





Ножица за клони с алуминиеви гръжки / Anvil looper aluminium tube / Foarfeca pentru crengi manrere aluminiu



AL



art. N	Length	box	ctn
382908	480 mm	1	6

- Алуминиеви телескопични дръжки
- Острие с незалепващо покритие
- Aluminium telescopic handle
- Non-stick blade coating
- Aluminu maner telescopic
- Non-stick de acoperire blade

Ножица за клони с метална гръжка / Hedge shear metal handle / Foarfeca pomi manere



art. N	Length	box	ctn
382917	675mm	1	6

- Метални дръжки
- Tube metal handles
- Tub de oțel mâner

Ножица и трион за високо рязане с гръжка / Pruning shear set with saw and handle / Foarfeca pentru pomi cu parghie + fierastrau



art. N	size	box	ctn
380110	160-280cm	1	12

- Телескопичната дръжка достига височина над 3м.
- Закалено острие
- Telescopic handle reaches over 3m height
- Tempered blade
- Telescopic mâner ajunge la o înălțime de peste 3m
- Temperat lama

Ножица и трион за високо рязане / Pruning shear set with saw / Foarfeca pentru pomi cu parghie



art. N	box	ctn
389903	1	24

- Закалено острие
- Tempered blade
- Temperat lama

Телескопична гръбжка / Telescopic handle / Telescopic maner

art. N	size	box
381602	1.28 - 2.42m	1

- Метална
- Metallic
- Metal



Ножица овоцарска / Pruning shear / Foarfeca pentru pomi cu parghie

art. N	box	ctn
389904	1	60

- Удобна и практична
- Comfortable and practical
- Confortabil și practice



Градински комплект 4 часту / Set garden tool 4 pcs / Set 4 unelte pt. gadinarit maner galben

art. N	box
380112	1

Съдържание:

- Широка лопата
- Тясна лоптка
- Разрохвач
- Инструмент за премахване на плевели

Contents:

- Wide shovel
- Narrow shovel
- Scraper
- Instrument for weed removal

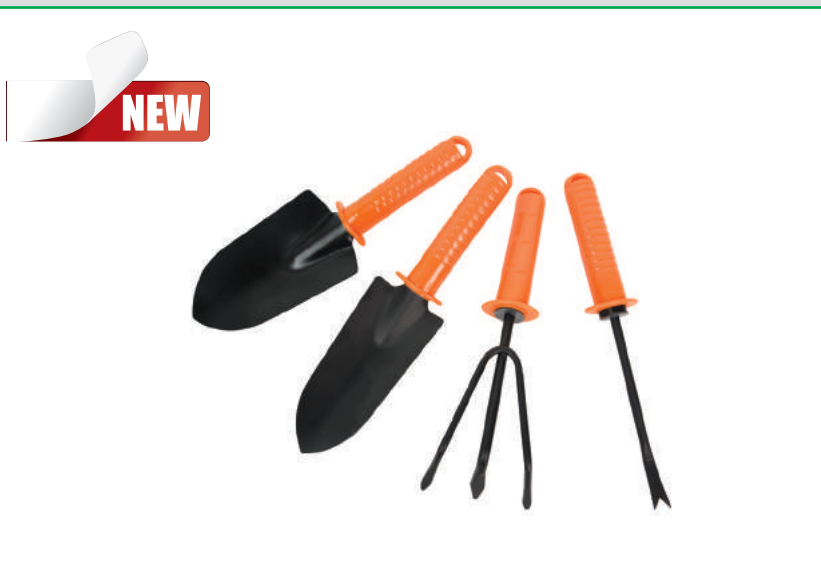



Гребло раздвижено с метална гръжка 1.2 m / Harrow 1.2m / Grebla ptr. frunze 1.2 m



art. N	Length	box	ctn
380442	120cm	1	24

- Възможност за регулиране разстояние между зъбите (20-65 см)
- Adjustable distance between the teeth (20-65 cm)
- Distanța reglabilă între dinți (20-65 cm)

Гребло мун аератор / Harrow orange handle / Grebla cu 2 randuri de dinți

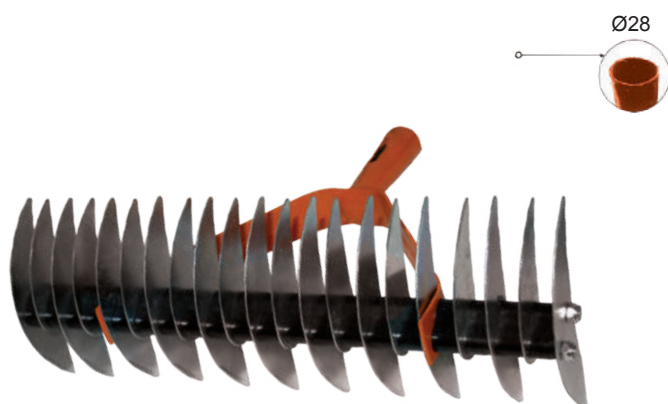

art. N	teeth(pcs)	box	ctn
380440	11 / 21	1	12

- За отстраняване на мъх, повяхнала трева и подравняване на почвата
- To remove moss, withered grass and leveling the soil
- Pentru a elimina uscat iarba și nivelarea solului

Гребло / Harrow / Grebla



art. N	teeth(pcs)	box	ctn
380511	16	1	50
380501	14	1	50

- За отстраняване на мъх, повяхнала трева и подравняване на почвата
- To remove moss, withered grass and leveling the soil
- Pentru a elimina uscat iarba și nivelarea solului

Гребло за листа / Harrow / Grebla

art. N	teeth(pcs)	box	ctn
380512	22	1	50

- Еластични зъби за събиране на листа и отпадъци от градината
- Elastic teeth for raking leaves and garden waste
- Dinți elastice pentru greblat frunze și deșeuri de grădină



Гребло за листа с гръжка / Harrow 1.2 m / Grebla ptr. frunze 1.2 m

art. N	teeth(pcs)	box
380455	22	1

- Еластични зъби за събиране на листа и отпадъци от градината
- Дървена дръжка 120 cm
- Elastic teeth for raking leaves and garden waste
- Wooden handle
- Dinți elastice pentru greblat frunze și deșeuri de grădină
- Mâner din lemn



Вила 4 зъба / Fork 4 prongs full forged / Furca 4 dinti forjata

art	W(mm)	L(mm)	box	ctn
384300	220	430	1	24

- Изцяло ковани
- Fully forged
- Complet forjate



Лопата права правоъгълна / Shovel spade head / Cazma patrata

art	W(mm)	L(mm)	(gr)	box	ctn
380701	210	400	720	1	12

- Закалена
- Hardened
- Temperat





Лопата права усилена / Russia style round shovel / Cazma semirotunda fara coada

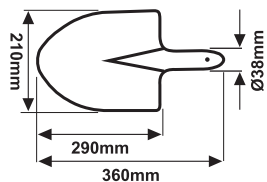

art	W(mm)	L(mm)	(gr)	box
380452	210	360	750	1

- Закалена
- Hardened
- Temperat

Лопата права стандартна без гръжка / Shovel standart without handle / Standard lopata

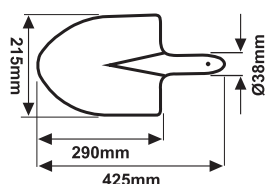

art	W(mm)	L(mm)	(gr)	box	ctn
380444	215	425	800	1	12

- Закалена
- Hardened
- Temperat

Лопата за пясък / Steel shovel for sand / Lopata patrata otel pt.nisip

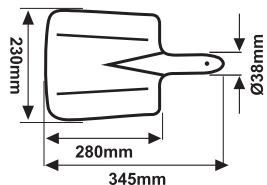

art	W(mm)	L(mm)	(gr)	box	ctn
380700	230	345	900	1	12

- Закалена
- Hardened
- Temperat

Лопата въглищарска без гръжка / Coal shovel without handle / Lopata carbune

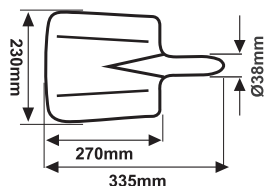

art	W(mm)	L(mm)	(gr)	box	ctn
380445	230	335	800	1	12

- Закалена
- Hardened
- Temperat

Лопата / Shovel / Loapata dreptunghiulara fara coada

art	W(mm)	L(mm)	(gr)	box
380453	235	345	800	1

- Закалена
- Hardened
- Temperat

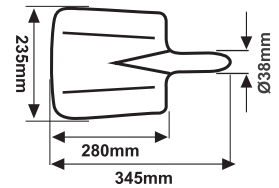

Лопата с гръжка / Shovel with handle / Lopata dreptunghiulara cu coada

art	W(mm)	L(mm)	(gr)	box
380454	235	345	800	1

- Закалена
- Hardened
- Temperat
- дървена дръжка 120 cm

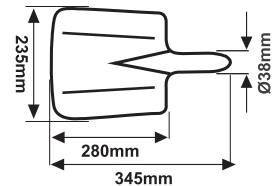
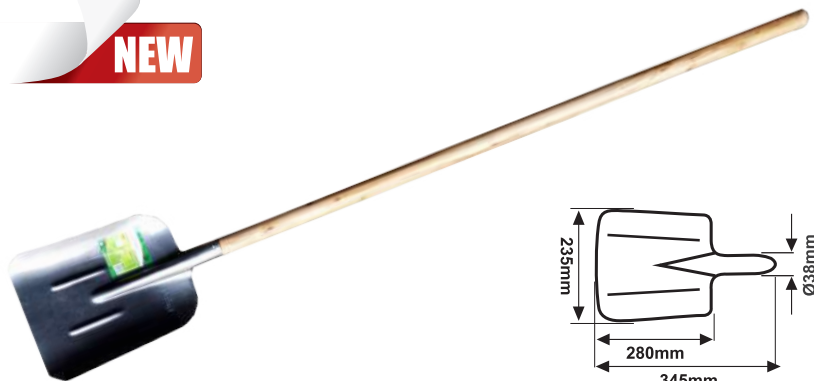

Лопата въглищарска с гръжка със захват / Coal shovel with handle with clamp / Lopata carbune cu maner

art	W(mm)	L(mm)	(gr)	box	ctn
380446	245	420	900	1	12

- Закалена
- Дължина на дръжката: 1m
- Hardened
- Handle length: 1m
- Temperat
- Măner Lungime: 1m

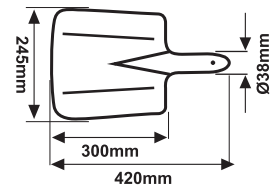
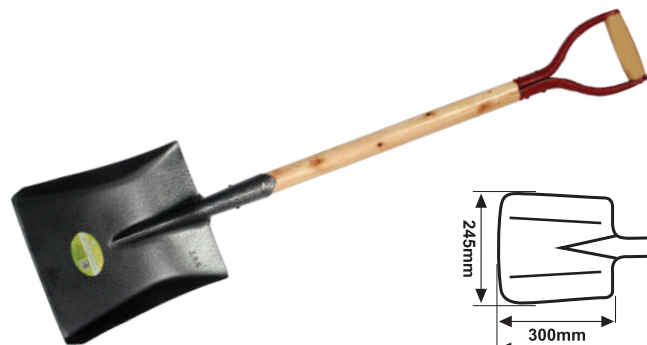

Купка / Pick Head / Tarnacop fara coada

art	W(mm)	L(mm)	(gr)	box	ctn
384100	10-55	570	2250	1	12

- Закалена
- Hardened
- Temperat

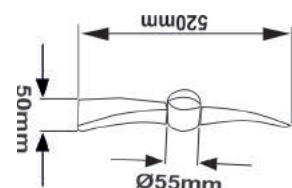



Гребло за сняг с гръжка и метална лайсна / Snow shovel with handle and metal blade / Lopata zapada cu maner si lama metalica



art. N	size	box	ctn
380447	40cm	1	10
380448	45cm	1	5

Гребло за сняг с метална лайсна LUX / Snow shovel with metal balde LUX / Zapada LUX



art. N	size	box
380513	45cm	1

- Клик система
- Click system

Плодоберач / Fruit picking device / Dispozitiv pentru cules fructe



art. N	size	box	ctn
380441	Ø-140mm	1	60

- С регулиращ захват
- With adjustable grip
- Cu prindere reglabil

Тел градинска / Drain cleaner tied / Fir pentru legat



art. N	Length	box	ctn
389901	100m	10	100
389902	20m	20	200

- Опаковка с резец
- Pack incisor
- Pack incisiv



Стойка за цветя / Flower Stand Body / Suport Flori

art. N	size	box	ctn
921105	40x180cm	1	1

- Лека, преносима конструкция, $\Phi 13\text{mm}$
- Lightweight, portable design, $\Phi 13\text{mm}$
- Design ușor și portabil, $\Phi 13\text{mm}$



Стойка за цветя / Flower Stand / Suport Flori

art. N	size	box	ctn
420201	60x60x75cm	1	1

- Лека, преносима конструкция
- Lightweight, portable design
- Design ușor și portabil

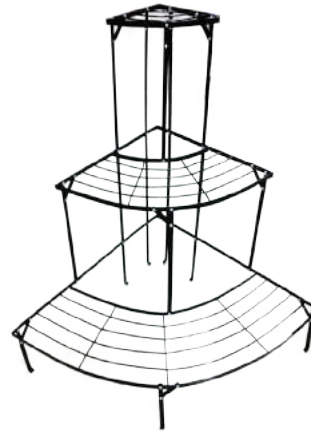

Столба за пълзящо растение / Flower stand body / Suport pt. flori

art. N	size	box	ctn
921102	30x100cm	1	40

- Лека, преносима конструкция
- Lightweight, portable design
- Design ușor și portabil



Столба за пълзящо растение / Flower stand body / Suport pt. flori

art. N	size	box	ctn
921103	40x150cm	1	15

- Лека, преносима конструкция
- Lightweight, portable design
- Design ușor și portabil

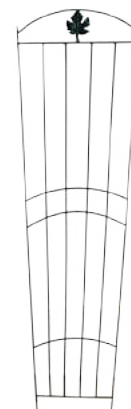



Арка / Flower Frame / Cadru de Flori

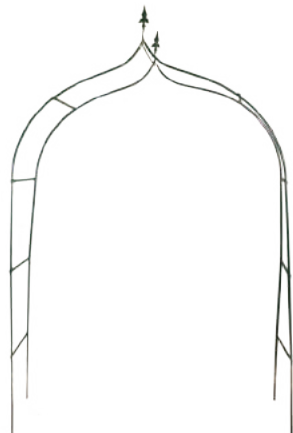

art. N	size	box	ctn
921101	255x140x38cm	1	1

- Лека, преносима конструкция
- Lightweight, portable design
- Design ușor și portabil

Арка / Flower Frame / Cadru de Flori



art. N	size	box	ctn
389907	240x140x37	1	1

- Лека, преносима конструкция
- Lightweight, portable design
- Design ușor și portabil

Арка / Garden arch / Arcada metalica pt.flori

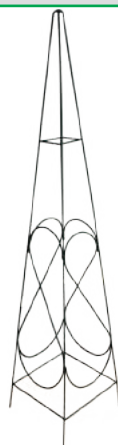

art. N	size	box	ctn
921104	150x30x30cm	1	1

- Лека, преносима конструкция
- Lightweight, portable design
- Design ușor și portabil

Арка / Garden arch / Arcada metalica pt.flori



art. N	size	box	ctn
921106	127x36x210cm	1	1

- Лека, преносима конструкция, Ф13mm
- Lightweight, portable design, Ф13mm
- Design ușor și portabil, Ф13mm

Стол сгъваем полиестер / Armrest chair polyester / Cotiera scaun poliester

art. N	size	box	ctn
929917	50x50x80cm	1	9

- Материал: стомана Ø16мм и полиестер 600D
- Сгъваем
- Material: Steel Ø16mm and 600D polyester
- Folding
- Material: oțel Ø16mm și poliester 600D
- Pliabil



  COLOR

Стол трипозиционен полиестер / Chair 3 positions polyester / Scaun cu 3 pozitii

art. N	size	box	ctn
929931	153x60x80cm	1	4

- Материал: стомана Ø25мм x 0.9мм и полиестер
- Сгъваем
- Material: steel Ø25mm x 0.9mm and polyester
- Folding
- Material: oțel Ø25mm x 0.9mm și poliester
- Pliabi



COLOR 

Лолка със століка / Cradle With Stand / Balansoar cu suport

art	Persons	size	box	ctn
929938	3	170x110x175cm	1	1

- Материал: стомана Ø25мм и полиестер
- Material: Steel Ø25mm and polyester
- Material: oțel Ø25mm și poliester





Стол стомана и полиестер / Chair steel and polyester / Catedra de otel si poliester



art. N	size	box	ctn
929937	54x60x85cm	1	6

- Материал: стомана Ø22мм и полиестер 600D
- Сгъваем
- Material: Steel Ø22mm and 600D polyester
- Folding
- Material: oțel Ø22mm și poliester 600D
- Pliabil

Стол стомана и полиестер / Chair steel and polyester / Catedra de otel si poliester



art. N	size	box	ctn
929932	52x55x74cm	1	10

- Материал: стомана Ø18мм и полиестер 600D
- Сгъваем
- Material: Steel Ø18mm and 600D polyester
- Folding
- Material: oțel Ø18mm și poliester 600D
- Pliabil

Шатра полиестер зелено и бяло / Gazebo PO green / Pavilion poliester



4 spikes
&
rope



art. N	size	box	ctn
929946	300x300x250cm	1	1

- Цвят: зелено и бяло: 160g/m2
- Размери конструкция: Ø 24/18/18x0.5mm
- Color; white /green and white/: 160g/m2
- Dimensions: Ø 24/18/18x0.5mm
- Polietilenă chioșc alb / verde și alb /: 160g/m2
- Dimensiuni: Ø 24/18/18x0.5mm

Шатра полиетилен / Gazebo PE / Pavilion polyetilena



art. N	size	box	ctn
929945	300x300x250cm	1	1

- Цвят: бял, /зелено и бяло/: 105g/m2
- Размери конструкция: Ø 24/18/18x0.5mm
- Color; white /green and white/: 105g/m2
- Dimensions: Ø 24/18/18x0.5mm
- Polietilenă chioșc alb / verde și alb /: 105g/m2
- Dimensiuni: Ø 24/18/18x0.5mm



TopGarden premium



TopGarden Premium - серията, която ще ви осигури гарантирано качество, комфорт и удоволствие от лекотата при работата ви в градината.

Убедете се лично в качеството на продуктите ни!

TopGarden Premium - series with guaranteed quality, comfort and pleasure of the ease of works in the garden.

Make sure personally in the quality of our TopGarden products!

TopGarden Premium - asigurand calitatea, confortul si placerea de utilizare a lor in gradina dvs.

Convingeti-va singuri de calitatea produselor TopGarden!



Пистолет поливен / Adjustable spray gun / Pistol pt. stropit multifunctional ABS

art. N	size	ctn
380986	1/2"	48

- Лек и здрав уред
- Удобна ергономична дръжка
- Плавно регулиране на водната струя: от фина мъгла до мощна плътна струя.
- Light and strong spray gun
- Comfortable ergonomic handle
- Variable water flow: from fine mist to a powerful jet of thick
- Lumina si sunet echipamente
- Confortabil mâner
- Debitul de apă variabil



Пистолет поливен 7 функции / 7-pattern spray gun set / Pistol pt. stropit 7 functii ABS

art. N	size	ctn
380987	1/2"	48

- Лек и здрав уред
- Удобна ергономична дръжка
- 7 режима на работа
- Light and strong spray gun
- Comfortable ergonomic handle
- 7 modes
- Lumina si sunet echipamente
- Confortabil mâner
- 7 moduli

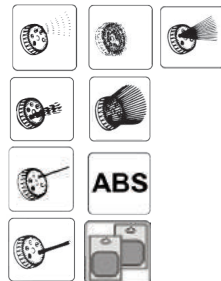

Водач за маркуч / Hose guide / Ghidaj furtun ABS

art. N	box	ctn
380989	1	24

- Осигурява плавно движение на маркуча
- Подходящ за поставяне върху външни ъгли
- Ensures smooth movement of the hose
- Suitable for installation on external corners
- Asigură buna circulație a furtunului
- Potrivit pentru instalare pe colțuri externe



Регуцирац съединител за конектори / Two way hose coupling / Prelungitor furtun

art. N	size	box	ctn
380960	3/4"	1	240

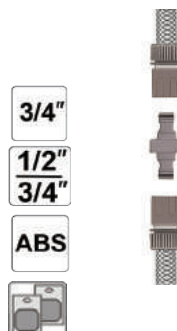



Съединител за маркуч / Hose mender / Mufa inadire furtun

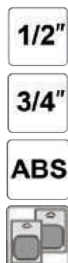

art. N	size	box	ctn
380984	1/2"	1	240
380985	3/4"	1	140

- За поправяне на повреден маркуч без инструменти.
- Повредената част се отрязва и на нейно място се поставя съединителя.
- To repair a damaged hose without tools.
- Cut the damaged part and in its place put the clutch.
- Pentru a repara un furtun deteriorat fără unelte.
- Tăiați partea deteriorată și în locul ei a pus ambreiajului

Конектор за маркуч / Hose connector / Conector furtun



art. N	size	box	ctn
380980	1/2"	1	240
380981	3/4"	1	240

- Бързо и удобно свързване на уреди за поливане към изхода на маркуча
- Съединението се сменя с леко издърпване
- Quick and easy connection of devices to the output of irrigation hose
- Unity is changed slightly pulling
- Conexiune rapidă și ușoară a dispozitivelor la ieșirea furtunului de irigare
- Unitatea este schimbat ușor trăgând

Конектор за маркуч със стоп / Hose connector water stop / Conector furtun ABS cu stop



art. N	size	box	ctn
380982	1/2"	1	240
380983	3/4"	1	140

- Бързо и удобно свързване на уреди за поливане към изхода на маркуча.
- Функцията "Стоп" спира притока на вода при разединяване на съединението.
- Сменя се с леко издърпване.
- Quick and easy connection of devices to the output of irrigation hose.
- The "Stop" stops the flow of water in the isolation of the compound.
- Replace with a slight pull.
- Conexiune rapidă și ușoară de dispozitive la ieșirea de furtun
- "Stop" oprește fluxul de apă în izolarea compusului.
- Înlocuiți-le cu o tragere ușoară.
- Lama de taiere tratata termic prin inductie
- Precizie călit clește cap



Разклонител за конектори три посочен / Three way connector / Splitter 3 cai

art. N	size	box	ctn
380962	3/4"	1	240

- Подходящ за съединение на маркучи с размер 3/4"
- Suitable for connection of hose size 3/4"
- Potrivit pentru conectarea dimensiunea furtunului 3/4"



Струйник с накрайници k-m 4 часту / Adjustable hose nozzle 4 pcs set / Set Pistol pentru stropit multifunctional 3 accesorii ABS

art. N	size	box	ctn
380988	1/2"	1	48

- Комплектът включва:
 - Струйник многофункционален
 - Адаптор 1/2" - 3/4"
 - Накрайници за маркуч 2 бр. (3/4" със и без стоп)

The set includes:

- Multy function spray nose nozzle
- Adaptor 1/2" - 3/4" - Hose connectors 2 pcs. (3/4" w/ and w/o stop button)

Include:

- Pistol de stropit multifunctional
- Adaptor 1/2" - 3/4"
- Conectori furtun 2 buc. (3/4")



Съединител за маркуч / Coupling hose connector / Conector baionet

art. N	size	box	ctn
400400	3/4"	10	100
400401	1"	10	100

- Месинг
- Brass





Съединител с външна резба 1" месинг / Coupling hose connector / Conector baionet



art. N	size	box	ctn
400900	1"	10	100

- Месинг
- Braas

Смукател месинг / Coupling hose connector / Conector baionet



art. N	size	box	ctn
400100	1"	1	50

- Месинг
- Възвратен клапан
- Brass
- Backflow preventer

Маркуч градински / PVC tree layers garden hose / PVC furtun de gradina



art. №	size	thickness	box
402109	1/2" x 15m	2.5 mm	1
402110	1/2" x 25m	2.5 mm	1
402111	1/2" x 50m	2.5 mm	1
402112	3/4" x 25m	2.5 mm	1
402113	3/4" x 50m	2.5 mm	1

- голяма гъвкавост
- атмосферна устойчивост - 4 сезона
- high flexibility
- weather resistant - 4 seasons

Маркуч смукателен к-т със смукател / Suction hose 7m / PVC furtun de gradina 7 m



art. №	size	box
402108	1 1/4" / 1" x 7m	1

- Смукател с възвратен клапан
- Sucker with a backflow preventer





Пулверизатор 2 l / Garden sprayer 2 l / Pulverizator 2 l

art. N	capacity(L)	box	ctn
380316	2	1	20

- Регулиране на водната струя - от плътна струя до фина мъгла
- Дюзата от месинг
- Adjusting the water jet-stream from a strong jet to a fine mist
- Nozzle Stainless Steel
- Reglementarea cu jet de apă-stream de jet puternic pentru a unei pulberi fine
- Alama duzal



Пръскачка градинарска 16 l / Garden sprayer 16 l / Pompa stropit 16 l

art. N	capacity(L)	box	ctn
380317	16	1	-

- Фиксирано бутало
- Уплътнена цедка
- Удължение от неръждаема стомана - усилено
- fixed piston
- densified strainer
- Extension of stainless steel - toifful



Фуния за хербициди / Herbicide funnel / Palnie pentru erbicidat

art. N	размер	box	ctn
380318	22 cm	1	-



Ръчна мотичка / Hand tine / Sapaliga gradinarit

art. N	size	box	ctn
384200	26	12	48

- Подходяща за разрохване, аериране и плевене на почвата
- Ергономична дръжка, която не позволява плъзгане на ръката и осигурява лекота при работа
- Ideal for loosening, aerating and weeding the soil
- Ergonomic handle that will not slip in the hand and provides ease of use
- Ideal pentru relaxare, aerare și plivitul solului
- Maner ergonomic, care nu va aluneca în mână și prevede usurinta de utilizare





Широк градинска лопатка / Hand wide shovel / Mini lopata pt. gradinarit



art. N	size	box	ctn
380449	35 cm	12	48

- За засаждане и пресаждане
- Ергономична дръжка, която не позволява плъзгане на ръката и осигурява лекота при работа
- For planting and transplanting
- Ergonomic handle that will not slip in the hand and provides easy to use
- Pentru plantare si transplantare
- Maner ergonomic, care nu va aluneca în mână și oferă ușurința de utilizare

Тясна градинска лопатка / Hand narrow shovel / Mini lopata pt. gradinarit ingusta



art. N	size	box	ctn
380450	35 cm	12	48

- За засаждане и пресаждане
- Ергономична дръжка, която не позволява плъзгане на ръката и осигурява лекота при работа
- For planting and transplanting
- Ergonomic handle that will not slip in the hand and provides easy to use
- Pentru plantare si transplantare
- Maner ergonomic, care nu va aluneca în mână și oferă ușurința de utilizare

Малко градинско гребло / Hand rake / Mini grebla pt. gradinarit 5 dinti



art. N	size	box	ctn
380514	29	12	48

- За изгребване на отпадъци и разрохкване на почвата
- Ергономична дръжка, която не позволява плъзгане на ръката и осигурява лекота при работа
- Ideal for loosening, aerating and weeding the soil
- Ergonomic handle that will not slip in the hand and provides ease of use
- Ușurința de excavare de deșeuri și sol relaxare
- Mâner ergonomic, care nu va aluneca în mână și oferă de utilizare

Ръчен разрохвач / Hand cultivator / Mini cultivator pt. gradinarit



art. N	size	box	ctn
380600	36	12	48

- За разрохкване и аериране на почвата, без да нанася щети на корените
- Ергономична дръжка, която не позволява плъзгане на ръката и осигурява лекота при работа
- For excavation of waste and soil loosening
- Ergonomic grip that will not slip in the hand and provides ease of use
- Ușurința de excavare de deșeuri și sol relaxare
- Mâner ergonomic, care nu va aluneca în mână și oferă de utilizare

Ръчно телено гребло / Hand tine rake / Mini grebla pt. frunze 9 dinti

art. N	size	box	ctn
380601	37	12	48

- За почистване на лехи и аериране на малки, обраснали с мъх площи
- Ергономична дръжка, която не позволява плъзгане на ръката и осигурява лекота при работа
- To clean the flower beds and aerating small areas overgrown with moss
- Ergonomic grip that will not slip in the hand and provides ease of use
- Pentru a curăța și zonele de paturi gazeificarea mici, prea mare, cu mâner moss
- Ergonomic, care nu va aluneca în mână și oferă ușurința de utilizare



Градинска лопатка за плевели / Hand weeder / Scafa de mana ptr. buruieni

art. N	box	ctn
380406	12	48

- За изкореняване на плевели
- For weed eradication



Садуло за луковци / Bulb Planter / Plantator pentru bulbi

art. N	box	ctn
380407	1	6



Градински кош - количка / Garden distbin / Cos de gradina

art. N	size	box	ctn
420301	360x400x1000mm	1	1

- Размери:
 - количка - 36 x 40 x 100 cm
 - кош - 27 x 29 x 52 cm
- Товароносимост - 15kg / 40L
- Dimensions:
 - Cart - 36 x 40 x 100 cm
 - Basket - 27 x 29 x 52 cm
- Load capacity - 15kg / 40L
- dimensiuni:
 - Coș - 36 x 40 x 100 cm
 - Cosuri cu - 27 x 29 x 52 cm





Градинску коу / Heavy duty pop-up container / Gunoii de gradina



art. N	size	box
420300	Ø45x58mm / 92L	1

- Усилена конструкция. Стоманено вџе Ø3,2mm
- Текстил 600D с PE покритие. Лесно и бързо сгъване и разгъване. Компактно съхранение
- Възможност за използване в градината и в дома
- Heavy duty, 600D clothes with PE coating and strong steel spring. Easy and quick to open and close.
- Compact storage and easy setup
- Idea for Garden and home using
- Design robust cu Ø 3,2 mm sârmă frânghie
- Textile 600D cu PE
- Уșор și pliere rapid și desfășurarea
- Depozitare Compact

Лонама / Germany style shovel / Loapata dreptunghiulara fara coada

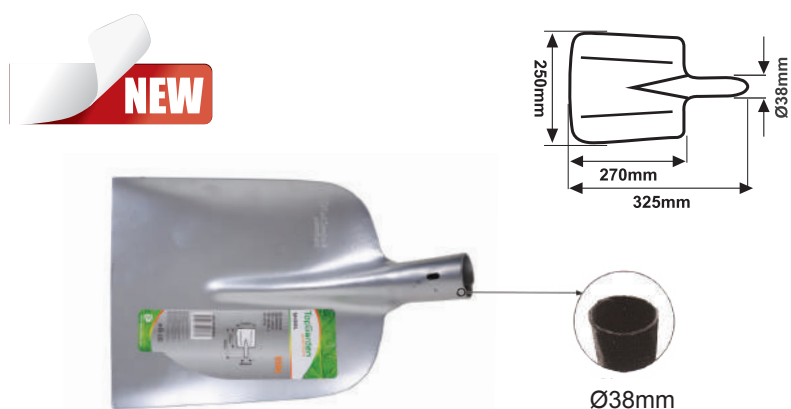

art	W(mm)	L(mm)	(gr)	box	ctn
380456	250	325	950	1	1

- Закалена
- Прахово боядисана
- Дебелина 1.7mm
- Hardened
- Powder coating
- Tickness 1.7mm

Лонама / Round shovel / Cazma semirotunda fara coada

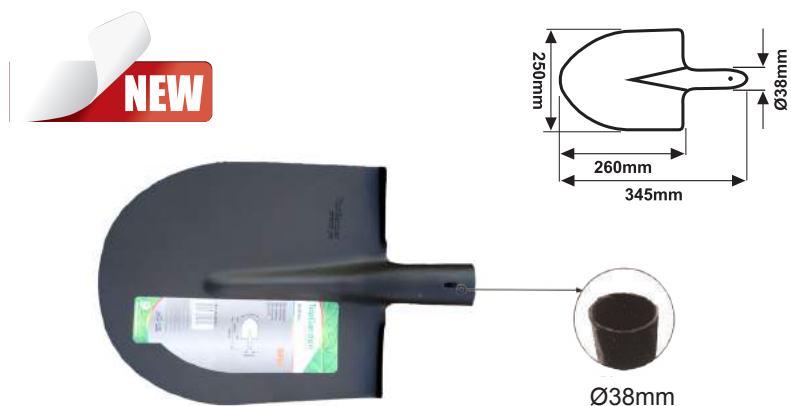

art	W(mm)	L(mm)	(gr)	box	ctn
380457	250	345	900	1	1

- Закалена.
- Прахово боядисана
- Дебелина 1.7mm
- Hardened
- Powder coating
- Tickess 1.7mm

Лонама / Round shovel / Cazma semirotunda fara coada

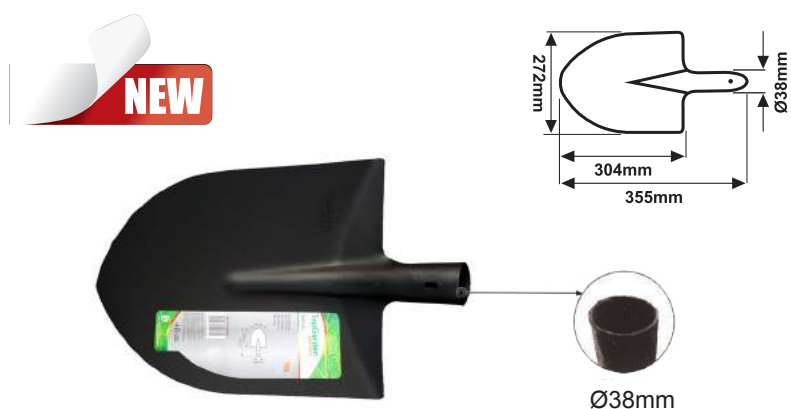

art	W(mm)	L(mm)	(gr)	box	ctn
380458	272	355	1000	1	1

- Закалена
- Прахово боядисана
- Дебелина 1.7mm
- Hardened
- Powder coating
- Tickess 1.7mm

Лопата / Shovel / Cazma semirotunda fara coada

art	W(mm)	L(mm)	(gr)	box	ctn
380451	270	380	1000	1	1

- Закалена
- Прахово боядисана
- Дебелина 1.7mm
- Hardened
- Powder coating
- Tickness 1.7mm

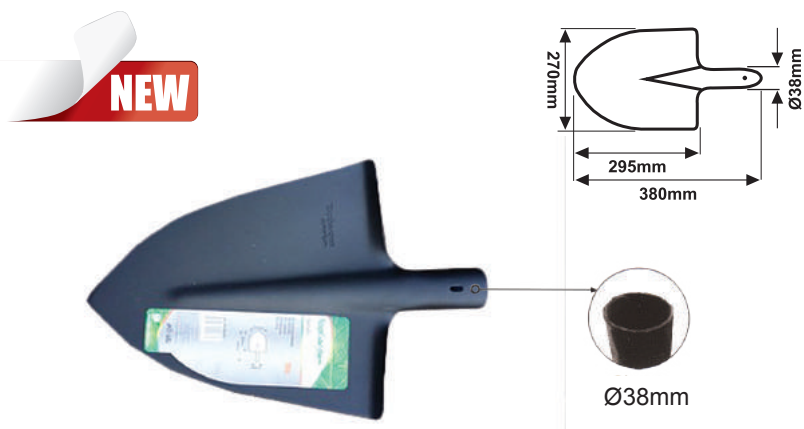

Лопата сгъваема / Foldable shovel / Lopata de pliere

art. N	box
380459	1

- Дължина до 500mm
- 160 x 280mm
- Total length 500mm
- 160 x 280mm



Гребло раздвижено / Harrow / Grebla

art. N	Teeth	box	ctn
380515	21	1	1

- Стоманено, епоксидно покритие, 21 зъба
- Отвор за дръжка - 28mm
- 21 зъба
- Регулиране на дистанцията от 40 до 50 см.
- Здрави, еластични зъби с дебелина 0,9mm
- Тегло: 0,500 kg
- 1. Teeth 21 - galvanized steel
- 2. Hole for handle 28mm
- 3. Adjustable teeth 40 - 50 cm
- 4. Strong flexible teet tickness 0,9mm
- 5. Total Weight 0,500 kg



Ножица за ашладисване с три приставки 5 часту k-m / 5 pcs set Grafting tool / Dispozitiv pentru altoit

art. N	box	ctn
377105	1	20

- Съдържание
- 1. Ножица за ашладисване Ω Omega 1бр
- 2. Отвертка PH 1бр
- 3. Ключ 10mm 1бр
- 4. Приставка V 1бр
- 5. Приставка U 1бр
- Contents:
- 1. Grafting tool Ω Omega 1pcs
- 2. Screwdriver PH 1pcs
- 3. Wrench 10mm 1pcs
- 4. Blade V 1pcs
- 5. Blade U 1pcs





Ножица лозарска / Drop forged pruning shears / Foarfeca ptr. vie



Ø 25mm



art. N	model	Length	box	ctn
377604	TGP 21	9" / 228mm		

- Режещо и подложно острие, произведени от висококачествена закалена стомана, за чист и прецизен отрез
- Whole piece drop forged 55# high carbon steel, 65#MN steel changeable blade
- Hardness: whole piece heat treatment hardness 54±2 HRC on body, 56±2 HRC on changeable blade
- Surface: fine polished on blade
- Handle: red powder coated
- Cutting capacity: 9" φ25mm

Резервно острие за ножица лозарска 9" TGP21 / Spare blade 9" TGP21 / Rezerve ptr. foarfeca



art. N	for model	box	ctn
377605	TGP 21	6	60

- Режещо и подложно острие, произведени от висококачествена закалена стомана, за чист и прецизен отрез
- 65#MN steel changeable blade
- 56±2 HRC blade

Ножица лозарска / Drop forged pruning shears / Foarfeca ptr. vie



Ø 25mm



art. N	model	Length	box	ctn
377602	TGP 22	9" / 228mm	6	60

- Режещо и подложно острие, произведени от висококачествена закалена стомана, за чист и прецизен отрез
- Whole piece drop forged 55# high carbon steel, 65#MN steel changeable blade
- Hardness: whole piece heat treatment hardness 54±2 HRC on body, 56±2 HRC on changeable blade
- Surface: fine polished on blade
- Handle: red powder coated
- Cutting capacity: 9" φ25mm

Резервно острие за ножица лозарска 9" TGP22 / Spare blade 9" TGP22 / Rezerve ptr. foarfeca



art. N	for model	box	ctn
377603	TGP 22	6	60

- Режещо и подложно острие, произведени от висококачествена закалена стомана, за чист и прецизен отрез
- 65#MN steel changeable blade
- 56±2 HRC blade

Ножица за клони / Looper bent handle / Foarfeca pomi manere

art. N	size	box	ctn
389911	760 mm	1	6

- Режещо и подложно острие, произведени от висококачествена закалена стомана
- Blade material: 65Mn, Teflon coated
- Bended steel tube handle with PP+TPR Grips



Ножица за клони / Looper bent handle / Foarfeca pomi manere

art. N	size	box	ctn
389912	760 mm	1	6

- Режещо и подложно острие, произведени от висококачествена закалена стомана
- Blade material: 65Mn, Teflon coated
- Bended steel tube handle with PP+TPR Grips



Ножица за клони с телескопични гръбжуци / Looper Telescopic / Foarfeca pomi manere

art. N	size	box	ctn
389913	650-910 mm	1	6

- Режещо и подложно острие, произведени от висококачествена закалена стомана
- Blade material: 65Mn, Teflon coated
- Bended steel tube handle with PP+TPR Grips



Ножица за клони със зъбчатка / Looper bent handle with gear / Foarfeca pomi manere

art. N	size	box	ctn
389914	720 mm	1	6

- Режещо и подложно острие, произведени от висококачествена закалена стомана
- Blade material: 65Mn, Teflon coated
- Bended steel tube handle with PP+TPR Grips





Ножица за храсту / Hedge shear / Foarfeca gard viu



art. N	size	box	ctn
389915	620 mm	1	6

- Режещо и подложно острие, произведени от висококачествена закалена стомана
- Blade material: 65Mn, Teflon coated
- Bended steel tube handle with PP+TPR Grips

Ножица за клони телескопична алуминиева / Anvil looper / Foarfeca pentru crengi manrere aluminiu



art. N	size	box	ctn
382915	26" - 40"	1	6

- Усилена глава, която спестява 40% от усилията
- Въглеродна стомана с тefлоново покритие
- Топлинно закалено острие
- Алуминиеви дръжки със заключващ механизъм
- Head saves 40% of the effort
- Carbon steel with Teflon coating head
- Heat tempered blade
- Aluminum handle with locking mechanism
- Greu de cap, care economisește 40% din oțelul efort
- Carbon cu strat de teflon
- Căldură călită mâner lama
- Aluminiu cu un mecanism de blocare

Уред за премахване на плевели / Weeder / Scafa de mana ptr. buruieni

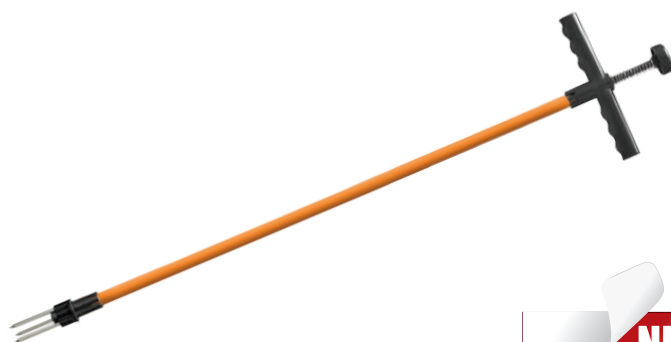

art. N	Length	box	ctn
380100	93.5 cm	1	1

- Прахово боядисана стоманена тръба
- Удобна "Т" ръкохватка
- Powder coated steel tube handle
- Comfortable "T" shape grip

Лопата за сняг с метална гръжка / Snow shovel with metal handle / Lopata zapada cu maner metal



art. N	Size	box
380460	W - 46cm, L - 130cm	1

- Метална дръжка
- Steel handle



MAKALON



Марката **Makalon** на „Евромастер Импорт Експорт“ обхваща няколко продуктови направления:

- Електрически ключове и контакти
- Разклонители и удължители
- Изолационни ленти

Продуктите с тази марка са известни с конкурентните си цени и предлаганото добро качество.

Makalon brand of “Euromaster Import-Export” LTD covers several product lines:

- Switches and plugs
- Extension sockets
- Insulation bands

The products of this brand are known for their competitive prices and good quality.

Marca **Makalon** a “Euromaster Import-Export” SRL cuprinde mai multe linii de produse:

- Intrerupatoare si prize
- Prelungitoare
- Benzi de izolare

Produsele acestui brand sunt cunoscute pentru prețurile lor competitive și buna calitate.



Ключ единичен МК-SW04 / One way switch MK-SW04 / Electric switch singur MK-SW04

art. N	box	ctn
700104	10	200

- Бял
- White
- Alb

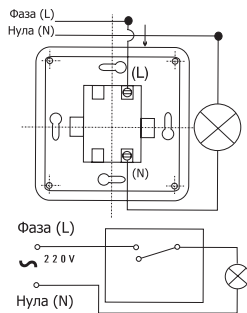

Ключ гевиаторен МК-SW03 / Two way switch MK-SW03 / Interuptator MK-SW03

art. N	box	ctn
700103	10	200

- Бял
- White
- Alb

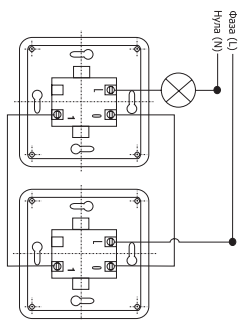

Ключ двоен МК-SW01 / Double one way switch MK-SW01 / Comutator MK-SW01

art. N	box	ctn
700101	10	200

- Бял, двоен
- White, double
- Alb, dublu

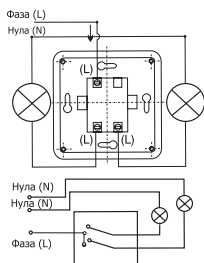

Ключ единичен светещ МК-SW05 / One way switch W Lamp MK-SW05 / Einterupator MK-SW05

art. N	box	ctn
700105	10	200

- Бял, светещ
- White, with led
- Alb, cu led

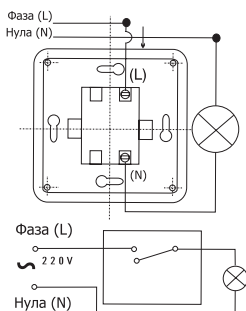

Ключ двоен светещ МК-SW02 / Double one way switch W Lamp MK-SW02 / Einterupator MK-SW02

art. N	box	ctn
700102	10	200

- Бял, светещ
- White, with led
- Alb, cu led

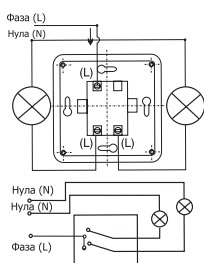



Ключ стълбищен МК-SW08 / Switch Pushbutton МК-SW08 / Einterupator cap- scara МК-SW08

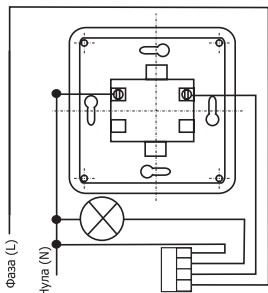

art. N	box	ctn
700108	10	200

- Бял, стълбищен
- White, for stairs
- Alb, pentru scari

Ключ потенциометричен МК-SW07 / Dimmer switch МК-SW07/ Variator tensuine МК-SW07

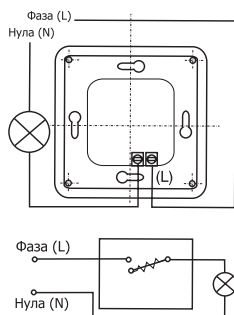

art. N	box	ctn
700107	9	180

- Бял
- White
- Alb

Контакт МК-SC01 / Socket МК-SC01 / Priza cu c.p МК-SC01

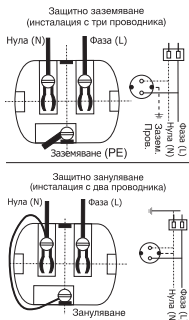

art. N	box	ctn
700109	10	200

- Бял
- White
- Alb

Контакт двоен МК-SC02 / Socket МК-SC02 / Priza duplu cu c.p МК-SC02

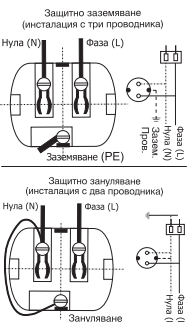

art. N	box	ctn
700110	7	140

- Бял
- White
- Alb

Контакт с канак МК-SC05 / Switch with closer МК-SC05 / Priza cu sarac МК-SC05

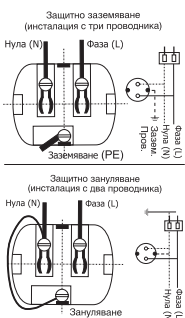

art. N	box	ctn
700113	9	180

- Бял
- White
- Alb



Контакт с канак МК-SC06 / Switch with closer MK-SC06 / Priza cu capac MK-SC06

art. N	box	ctn
700114	7	140

- Бял, външен
- White, outdoor
- Alb, condițiile în aer liber

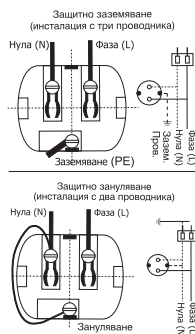

Контакт за телевизор МК-SC03 / Electric Switch for TV MK-SC03 / Priza TV MK-SC03

art. N	box	ctn
700111	10	200

- Бял, стандартен
- White, conventional
- Alb, convențional



Контакт за телефон МК-SC04 / Electric Switch for telephone MK-SC04 / Priza telephone MK-SC04

art. N	box	ctn
700112	10	200

- Бял, стандартен
- White, conventional
- Alb, convențional



Угължител на макара / Cable Reel / Pe soclu Stand

art. N	size	box	ctn
700706	15m	3	6
700713*	25m	4	4
700708*	50m	4	4

- 4 гнезда
- With 4 sockets
- Contact cu 4 prize



700706

*700713, 700708

Угължител на макара 25m / Cable Reel 25m / Pe soclu Stand 25m

art. N	size	box	ctn
700772	25m	1	1





Угължител / Extension cord / Prelungitor simplu



art. N	size	box	ctn
700731	5m	10	48
700707	10m	10	48
700732	15m	10	48

- Бял, стандартен
- White, conventional
- Alb, convențional

Угължител / Extension cord / Prelungitor simplu



art. N	size	box	ctn
700766	10m	10	48
700767	15m	10	48
700768	20m	10	48

- Оранжев, стандартен
- Orange, conventional
- Portocaliu, convențional

Разклонител 3 гнезда МК / Socket 3 MK / Prelungitor 3 price



art. N	size	box	ctn
700750	1.5m x 1.5mm ²	-	50
700752	3.0m x 1.5mm ²	-	25

- Бял, с кабел
- White, with cable
- Alb, cu cablu

Разклонител 4 гнезда МК / Socket 4 MK / Prelungitor 4 price



art. N	size	box	ctn
700755	1.5m x 1.5mm ²	-	40
700757	3.0m x 1.5mm ²	-	25

- Бял, с кабел
- White, with cable
- Alb, cu cablu

Разклонител 5 гнезда МК / Socket 5 MK / Prelungitor 5 price



art. N	size	box	ctn
700760	1.5m x 1.5mm ²	-	40
700762	3.0m x 1.5mm ²	-	25

- Бял, с кабел
- White, with cable
- Alb, cu cablu



Разклонител 6 гнезда МК / Socket 6 MK / Prelungitor 6 price

art. N	size	box	ctn
700764	1.5m x 1.5mm2	-	25

- Бял, с кабел
- White, with cable
- Alb, cu cablu



Разклонител 3 гнезда с ключ МК / Socket 3 with switch MK / Prelungitor 3 price cu interupator

art. N	size	box	ctn
700751	1.5m x 1.5mm2	-	50
700753	3.0m x 1.5mm2	-	25
700754	5.0m x 1.5mm2	-	20

- Бял, с ключ
- White, with switch
- Alb, cu intrerupator



Разклонител 4 гнезда с ключ МК / Socket 4 with switch MK / Prelungitor 4 price cu interupator

art. N	size	box	ctn
700756	1.5m x 1.5mm2	-	40
700758	3.0m x 1.5mm2	-	25
700759	5.0m x 1.5mm2	-	20

- Бял, с ключ
- White, with switch
- Alb, cu intrerupator



Разклонител 5 гнезда с ключ МК / Socket 5 with switch MK / Prelungitor 5 price cu interupator

art. N	size	box	ctn
700761	1.5m x 1.5mm2	-	40
700763	3.0m x 1.5mm2	-	25

- Бял, с ключ
- White, with switch
- Alb, cu intrerupator



Разклонител 6 гнезда с ключ МК / Socket 6 with switch MK / Prelungitor 6 price cu interupator

art. N	size	box	ctn
700765	1.5m x 1.5mm2	-	25

- Бял, с ключ
- White, with switch
- Alb, cu intrerupator





Разклонител 1 шуко 2 USB / Group socket 1 schuko 2 USB / Prelungitor 1 schuko 2 USB



**Dual USB
2.1A**

art. N	box	ctn
700773	12	48

- Бял
- White
- Alb

Разклонител двоен мин шуко МК / Socket 2 / Prelungitor 2 price



art. N	box	ctn
700769	-	125

- Бял
- White
- Alb

Разклонител троен 1 шуко МК / Socket 3 / Prelungitor 3 price



art. N	box	ctn
700771	-	125

- Бял
- White
- Alb

Разклонител троен мин шуко МК / Socket 3 / Prelungitor 3 price

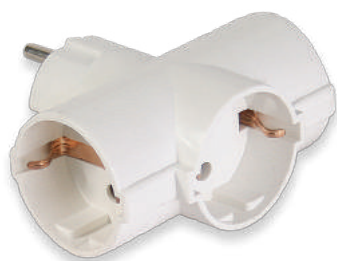

art. N	box	ctn
700770	-	125

- Бял
- White
- Alb

Щенсел шуко плосък / Flat Schuko Plug / Stecher schuko extra plat



art. N	box	ctn
700775	100	200

- Бял
- White
- Alb



Адаптер ел. универсален 5 вида към шuko / International Universal All in One World Travel Adapter / Adaptor sua preturi 5 specii

art. N	box	ctn
700774	50	100

- Бял
- White
- Alb



Изолурбанг / PVC Insulation tape / Banda izoliera

art. N	size	box	ctn
721101	18mm x 20m	10	200
721102	18mm x 20m	10	200
721103	18mm x 20m	10	200
721104	18mm x 20m	10	200
721105	18mm x 20m	10	200
721106	18mm x 20m	10	200

- Различни цветове
- Different colors
- Diferite culori



Машина за лепене на полиетилен / Sticking machine / Dispozitiv lipit

art. N	size	box	ctn
129906	250mm / 350W	-	10
129907	400mm / 600W	-	10



Нагревател с тефлонова лента резервен / Heater Teflon tape / Banda de incalzire teflon

art. N	size	box	ctn
129909	250mm / 350W	-	20
129910	400mm / 600W	-	20



Поялник за PP тръби 800W 3 глави Ø20-32mm / PPR pipe welding / Dispozitiv ptr. lipit tevi

art. N	box	ctn
076101	-	10

- 800W;
- 3 глави: Ø20, 25, 32mm
- 800W
- 3 heads: Ø20, 25, 32mm
- 800W
- 3 сапете: Ø20, 25, 32mm



topchrome



Продуктите **TopChrome** са гаранция за практичност и достъпност при гамата санитарни аксесоари, смесителни батерии, душове и други продукти. Те внасят елегантност и усещане за уют във вашата баня и кухня.

Комфортът и удобството на потребителите са сред основните приоритети на марката. Освен на тях, залагаме и на постигнатия баланс между функционален дизайн, удобство и приемливи цени.

The product range of **TopChrome** is a guarantee for practicality and affordability of sanitary accessories, faucets, showers and other products, bringing elegance and comfort into any bathroom and kitchen.

Comfort and convenience of customers are among the main priorities of the brand. We rely on the maximum achieved balance between functional design, comfort and affordability.

Gama produselor **TopChrome** reprezintă asigurarea practicalității și accesibilității pentru accesoriile sanitare, robinete, dusuri și alte produse care aduc eleganță și confort în orice baie și bucatărie.

Confortul și avantajul clienților se află în topul priorităților brandului. Ne bazăm pe realizarea celui mai bun echilibru dintre designul funcțional, confort și accesibilitate.

Смесител едноръкохватков / Faucet / Baterie chiuveta

art. N	box	ctn
800110	1	20

- Стоящ, малък
- Керамична глава
- Sink type, small
- Ceramic cartridge
- Tip chiuveta, mic
- Cartus ceramic



Смесител едноръкохватков / Faucet / Baterie chiuveta

art. N	box	ctn
809910	1	20

- Стоящ, къс чучур
- Керамична глава
- Sink type, short spout
- Ceramic cartridge
- Tip chiuveta, brat scurt
- Cartus ceramic



Смесител едноръкохватков / Faucet / Baterie chiuveta

art. N	box	ctn
800103	1	20

- Стоящ, дълъг чучур
- Керамична глава
- Sink type, long spout
- Ceramic cartridge
- Tip chiuveta, brat lung
- Cartus ceramic



Смесител едноръкохватков, "S" лебедка / Faucet, "S" winch / Baterie chiuveta bucatarie "S"

art. N	box	ctn
800108	1	20

- Тип - степен
- "S" лебедка, къс
- Керамична глава
- Wall type
- "S" winch, short
- Ceramic cartridge
- Pe perete cu brat scurt
- Cartus ceramic



Смесител едноръкохватков, "S" лебедка / Faucet, "S" winch / Baterie chiuveta bucatarie "S"

art. N	box	ctn
800105	1	20

- Тип - степен
- "S" лебедка, дълъг
- Керамична глава
- Wall type
- "S" winch, long
- Ceramic cartridge
- Pe perete cu brat lung
- Cartus ceramic





Смесител едноръкохватков / Faucet / Baterie chiuveta



art. N	box	ctn
800111	1	20

- Стоящ, висок чучур
- Керамична глава
- Sink type, high spout
- Ceramic cartridge
- Tip chiuveta, brat inalt
- Cartus ceramic

Смесител гвуръкохватков / Faucet, two handles / Baterie chiuveta perete



art. N	box	ctn
809902	1	20

- Тип - степен
- С аератор
- Wall type
- With aerator
- Pe perete, cu aerator

Смесител гвуръкохватков / Faucet, two handles / Baterie chiuveta perete



art. N	box	ctn
809916	1	20

- Тип - степен
- Висок чучур
- Wall type
- High spout
- Pe perete, cu brat inalt

Смесител с подвижен гуш, къс чучур / Bath water faucet, short spout / Baterie cada-dus, brat scurt



art. N	box	ctn
800101	1	10

- Тип - степен, Едноръкохватков, Керамична глава
- Душ с 3 функции
- Дължина на шланга: 155cm
- Wall type, Single handle, Ceramic cartridge,
- Shower with 3 functions, Hose length: 155cm
- Pe perete, Monocomanda, Cartus ceramic,
- Dus cu 3 functii
- Lungime furtun: 155cm

Смесител с подвижен гуш, "S" лебедка / Bath water faucet, "S" winch / Baterie baie "S"



art. N	box	ctn
800106	1	10

- Тип - степен, Едноръкохватков, Керамична глава
- "S" лебедка
- Душ с 3 функции, дължина на шланга: 155 cm
- Wall type, Single handle, Ceramic cartridge, "S" winch
- Shower with 3 functions, Hose length: 155 cm
- Pe perete, Monocomanda, Cartus ceramic,
- Dus cu 3 functii, Lungime furtun: 155 cm

Смесител за биге / Bidet faucet / Bateriae bideu

art. N	box	ctn
800109	1	20



Душ подвижен "8 в 1", на стойка / Bathroom shower "8 in 1", with stand / Set dus "8 in 1", cu suport

art. N	box	ctn
809906	1	30

- Дължина на стойката: 60 cm
- Stand length: 60 cm
- Lungime suport: 60cm

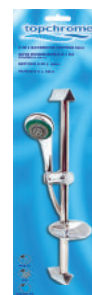

Душ подвижен, бял / Bathroom shower, white / Dus baie, alb

art. N	box	ctn
800107	1	50

- Дължина на шланга: 150 cm
- Hose length: 150 cm
- Lungime furtun: 150 cm



Душ подвижен "4 в 1" / Bathroom shower "4 in 1" / Set dus "4 in 1"

art. N	box	ctn
809942	1	50

- Голяма слушалка
- 4 функции
- Дължина на шланга: 155 cm
- Big head
- 4 functions
- Hose length: 155 cm
- Para dus cu 4 functii
- Lungime furtun: 155 m



Душ подвижен "3 в 1" / Bathroom shower "3 in 1" / Set dus "3 in 1"

art. N	box	ctn
809943	1	50

- 3 функции
- Дължина на шланга: 155 cm
- 3 functions
- Hose length: 155 cm
- 3 functii
- Lungime furtun: 155 cm





Шлаух за подвижен душ / Tube for shower / Furtun pentru dus



art. N	size	box	ctn
809944	1.5m	1	100

Канела / Water tap / Robinet



art. N	size	box	ctn
820103	1/2	10	100
820104	1/2	10	100
820105	1/2	1	100

- 820103 никелирана, дълга
- 820104 никелирана, с вграден аератор
- 820105 никелирана, с шуцер

- 820103 nickel - plated, long
- 820104 nickel - plated with aerator
- 820105 nickel - plated with orifice

- 820103 nichel - placat, lung
- Nichel 820104 - placat cu aerator
- Nichel 820105 - placat cu orificiu

Канела / Water tap / Robinet

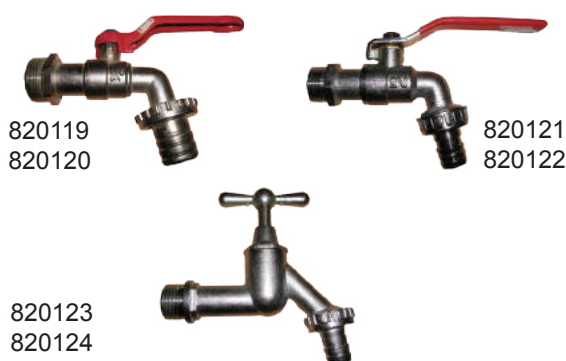

art. N	size / NW	box	ctn
820119	1/2", 110gr	12	120
820120	3/4", 150gr	12	120
820121	1/2", 170gr	12	120
820122	3/4", 215gr	10	100
820123	1/2", 200gr	12	120
820124	3/4", 230gr	10	100

- 820119, 820120 с шуцер
- 820121, 820122 с шуцер, метална дръжка
- 820123, 820124 с шуцер T-дръжка
- 820119, 820120 with orifice
- 820121, 820122 with orifice, metal handle
- 820123, 820124 with orifice T-handle
- 820119, 820120, cu orificiu
- 820121, 820122 cu orificiu, mâner din metal
- 820123, 820124 cu orificiu maner T

Етажерка за баня / Bathroom shelf / Raft baie

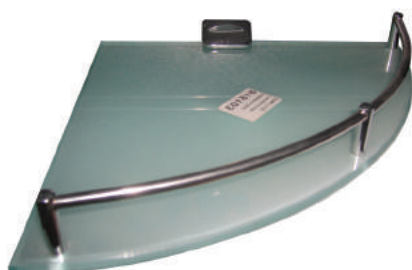

art. N	size	box	ctn
815102	200mm	1	30
815103	250mm	1	20

- Стъклена, ъглова
- Glass body, corner
- Corp de sticlă, colț

Етажерка за баня, гвойна / Bathroom shelf, double / Baie raft, dublu

art. N	size	box	ctn
815104	250mm	1	12

- Стъклена, ъглова, двойна
- Glass double body, corner
- Corp de sticla dublu, colț



Етажерка за баня / Bathroom shelf / Raft baie

art. N	size	box	ctn
815105	500mm	1	24
815106	600mm	1	24

- Стъклена
- Glass body
- Corp de sticla



Акcesoари за баня хром-бяло, к-м 6 бр. / Bathroom set 6pcs, chromium-white / Accesorii baie, set 6pcs crom-alb

art. N	box	ctn
810102	1	10

- 2 x закачалки за хавлия - халка и лост
- 1 x закачалка, малка
- 1 x поставка за тоалетна хартия
- 1 x сапунерка с чинийка, 1 x поставка с чаша
- 2 x towel hanger - straight bar / ring
- 1 x small hanger, 1 x toilet roll holder
- 1 x soap-dish, glass plate
- 1 x tumbler holder
- 2 x suport prosop - bara dreapta / inel
- 1 x cuier mic; 1 x suport hartie igienica
- 1 x suport sapun cu platou de sticla
- 1 x suport periute



Акcesoари за баня хром, к-м 6 бр. / Bathroom set 6pcs, chromium / Accesorii baie, set 6pcs, crom

art. N	box	ctn
815901	1	10

- 2 x закачалки за хавлия - халка и лост
- 1 x закачалка, малка
- 1 x поставка за тоалетна хартия
- 1 x сапунерка с чинийка, 1 x поставка с чаша
- 2 x towel hanger - straight bar / ring
- 1 x small hanger, 1 x toilet roll holder
- 1 x soap-dish, glass plate
- 1 x tumbler holder
- 2 x suport prosop - bara dreapta / inel
- 1 x cuier mic; 1 x suport hartie igienica
- 1 x suport sapun cu platou de sticla
- 1 x suport periute





ПостаВка за хавлици, инoкс / Holder for bathrobes, inox / Suport pentru halat de baie



art. N	box	ctn
815107	1	18

Закачалка за хавлия / Towel hanger - straight bar / Suport prosop - bara dreapta



art. N	box	ctn
815121	1	20

Закачалка за хавлия - халка / Towel hanger - ring / Suport prosop - inel



art. N	box	ctn
815123	1	20

Дозатор за течен сапун, пластмасов / Soap dispenser, plastic / Dozator sapun lichid, plastic



art. N	box	ctn
815101	1	50

Дозатор за течен сапун с постаВка / Soap dispenser, with holder / Dozator sapun lichid, cu suport



art. N	box	ctn
815128	1	20

Сапунерка стъклена / Soap-dish, glass plate / Suport sapun, farfurie de sticla

art. N	box	ctn
815124	1	20



Сапунерка, решетъчна / Soap-dish, gridded / Suport sapun, cu gratar

art. N	box	ctn
815126	1	20



Поставка с чаша / Tumbler holder / Suport periute

art. N	box	ctn
815122	1	20



Поставка за тоалетна хартия / Toilet roll holder / Suport pentru hartie igienica

art. N	box	ctn
815127	1	20



Четка за тоалетна чиния, инокс / Toilet brush, inox / Perie toaleta, inox

art. N	box	ctn
815109	1	60

- Метална поставка с капаци
- Metal holder with caps
- Suport de metal cu capace





Четка за тоалетна чиния / Toilet brush / Perie toaleta



art. N	box	ctn
815125	1	10

- Стъклена поставка
- Glass holder
- Suport de sticla

Кошче за боклук, инокс / Trash bin, inox / Cos inox



art. N	size	box	ctn
815111	3L	1	12
815112	5L	1	12

- С педал за отваряне
- With opening pedal
- Cu pedala

Огледало за баня / Bathroom mirror / Oglinda de la baie



art. N	size	box	ctn
815501	600x450mm	1	20

- Стеснен профил
- Side-narrowed shape
- Forma de clesidra

Огледало за баня / Bathroom mirror / Oglinda de la baie



art. N	size	box	ctn
815502	600x450mm	1	20

- Полуовален профил
- Half-oval shape
- Forma ovala in partea superioara

Огледало за баня / Bathroom mirror / Oglinda de la baie



art. N	size	box	ctn
815503	600x450mm	1	20

- Стеснен полуовален профил
- Narrowed half-oval shape
- Forma ovala in partea superioara

Огледало за баня / Bathroom mirror / Oglinda de la baie

art. N	size	box	ctn
815504	600x450mm	1	20

- Профил - скосен овал
- Cut-oval shape
- Ovala



Огледало за баня / Bathroom mirror / Oglinda de la baie

art. N	size	box	ctn
815505	600x450mm	1	20

- Овален профил
- Oval shape
- Ovala



Завеса за баня / Shower curtain / Perdea dus

art. N	size	box	ctn
939920	1.80x1.80m	1	120
939921	1.80x1.80m	1	72

- Материал / Material: PE
 Дебелина / Thickness / Grosime:
 - 939920 - 3 μ
 - 939921 - 7 μ



Тефлонова лента / Teflon tape / Banda teflon

art. N	size	box	ctn
829902	10m	12	2400
829903	10m	12	240

- 829902 дължина 10m
- 829902 length 10m
- 829902 10m lungime
- 829903 к-т 3 бр., блистер, дължина 10m
- 829903 3 pcs set, blister packing, length 10m
- 829903 3 buc set, ambalare blistere, lungime 10m



Маншон за тоалетна чиния / WC muff / Mufa flexibila WC

art. N	size	box	ctn
820703	Ø110	-	30



STUTTGART
BAUKRAFT
POWER TOOLS



www.euromasterbg.com

Продуктовата гама на **Baukraft** е гаранция за практичност и достъпност на гама акумулаторни и електрически машини, внасящи усещане за сигурност и качество на достъпна цена.

С новите машини и усъвършенстване на моделите, спечелили Вашето доверие с доказаното си качество, ние добавяме допълнителни ползи и предимства и адаптираме продуктите към пазарната среда.

Комфортът и удобството на потребителите са сред основните приоритети на марката. Освен на тях, залагаме и на постигнатия баланс между функционален дизайн, удобство и приемливи цени.

The **Baukraft** product range guarantees the practicality and availability of a range of rechargeable and electric machines that deliver a sense of security and quality at an affordable price.

With the new machines and improvement of models, which earn your trust with proven quality, we add additional benefits and advantages and adapt our products to the market environment.

The comfort and convenience of the customers are among the main priorities of the brand. We rely on the maximum achieved balance between functional design, comfort and affordability.

Gama produselor **Baukraft** asigură practic și gama de accesibilitate, baterii și mașini electrice, aducând un sentiment de securitate și de calitate la un preț accesibil.

Cu noi mașini și îmbunătățirea modelelor câștigat încrederea în calitate dovedită, vom adăuga beneficii și avantaje suplimentare și să adapteze produsele lor la mediul de piață.

Confortul și avantajul clienților se afla în topul priorităților brandului. Ne bazam pe realizarea celui mai bun echilibru dintre designul functional, confort și accesibilitate.



Акумулаторна Бормашина Li-ion 12V 2-ск. 2 бат. и аксесоари 1300mAh / Cordless Drill Li-ion 12V 2-speed 2 batteries and accessories 1300mAh / Bormasina Cu Acumulator Li-ion 12V 2 viteze 2 baterii si accesorii 1300mAh

art. №	model	box	ctn
030602	BK-CDL14		8

LITHIUM-ION
BATTERY



Зарядно за акумулаторна бормашина Li-ion 12V 1300mAh / Charger for Cordless Drill Li-ion 12V 1300mAh / Incarcator acumulator Li-ion 12V 1300mAh

art. №	for model	box	ctn
032121	RD-CDL12, 13 & BK-CDL14		40

LITHIUM-ION
BATTERY



Батерия за акумулаторна бормашина Li-ion 12V 1300mAh / Battery for Cordless Drill Li-ion 12V 1300mAh / Acumulator Cu Bormasina Li-ion 12V 1300mAh

art. №	for model	box	ctn
131141	RD-CDL12, 13 & BK-CDL14		40

LITHIUM-ION
BATTERY



Бормашина 650W 13mm самозатягащ патронник / Impact Drill 650W 13mm keyless chuck / Bormasina 650W 13mm mandrina rapida

art. №	model	box	ctn
010132	BK-ID30		10





Бглошлайф 125mm 710W / Angle Grinder 125mm 710W / Polizor Unghiular 125mm 710W



art. №	model	box	ctn
020801	BK-AG46		6



Комплект 3 в 1 - Бормашина 500W, Бглошлайф 500W, Прободен трион 350W / Set 3 in 1 - Impact drill 500W, Angle grinder 500W, Jig saw 350W / SET 3 on 1 - Masina de gaurit, Polizor unghiular, Ferestrau pendular



art. №	model	box	ctn
019801	BK-IAJ05		4

Перфоратор 620W 24mm / Rotary Hammer 620W 24mm / Polizor Unghiular 125mm 710W



art. №	model	box	ctn
012201	BK-HD32		5



ACCESSORIES:
HAMMER DRILLS Ø6, Ø8, Ø10X150mm
POINTED - AND FLAT CHISELS 14X250mm
ADDITIONAL HANDLE WITH DEPTH GAUGE

Кървач 1500W 32mm SDS-plus / Rotary Hammer 1500W 32mm / Ciocan Rotopercutor 1500W 32mm



art. №	model	box	ctn
013122	BK-HD34		2



ACCESSORIES:
SDS-plus 8x150 mm drill bit
SDS-plus 10x150 mm drill bit
SDS-plus 12x150 mm drill bit
SDS-plus 14x250 mm mm flat chisel
SDS-plus 14x250 mm pointed chisel



Циркулар рѣчен Ø185mm 1200W лазер / Circular Saw Ø185mm 1200W laser / Ferastrau Circular Ø185mm 1200W

art. №	model	box	ctn
052107	BK-CS23		4



Пробоген трион 650W 65mm рез.об. / Jig Saw 650W 65mm / Ferastrau Pendular 650W 65mm

art. №	model	box	ctn
050114	BK-JS23		10



Виброшлаѳ 150W 90x187mm / Sander 150W 90x187mm / Slefuitor cu vibratii 150W 90x187mm

art. №	model	box	ctn
040113	BK-SA20		10



Пистолет за горещ въздух 2000W 2 смен. / Heat Gun 2000W 2 rates / Pistol cu aer cald 2000W 2 rate

art. №	model	box	ctn
074308	BK-HG19		10





Косачка-тример 250W 220mm / Grass Trimmer 250W 220mm / Trimmer pentru iarba 250W 220mm



art. №	model	box	ctn
075538	BK-GT25		15

Косачка 1000W 320mm 35L / Lawn Mower 1000W 320mm 35L / Masina de tuns iarba 1000W 320mm 35L



art. №	model	box	ctn
075320	BK-LM22		1

Помпа водна потопяема за мръсна вода 400W 1" max 125L/min 5m / Submersible Pump for Sewage Water 400W 1" max 125L/min 5m / Pompa de apa submersibila 400W 1" max 125L/min 5m



art. №	model	box	ctn
070137	BK-WP30		4

GREEN TOOLS



www.euromasterbg.com

Продуктовата гама на **Green Tools** е гаранция за практичност и достъпност на гама акумулаторни и електрически машини, внасящи усещане за сигурност и качество на достъпна цена.

С новите машини и усъвършенстване на моделите, спечелили Вашето доверие с доказаното си качество, ние добавяме допълнителни ползи и предимства и адаптираме продуктите към пазарната среда.

Комфортът и удобството на потребителите са сред основните приоритети на марката. Освен на тях, залагаме и на постигнатия баланс между функционален дизайн, удобство и приемливи цени.

The **Green Tools** product range guarantees the practicality and availability of a range of rechargeable and electric machines that deliver a sense of security and quality at an affordable price.

With the new machines and improvement of models, which earn your trust with proven quality, we add additional benefits and advantages and adapt our products to the market environment.

The comfort and convenience of the customers are among the main priorities of the brand. We rely on the maximum achieved balance between functional design, comfort and affordability.

Gama produselor **Green Tools** asigură practic și gama de accesibilitate, baterii și mașini electrice, aducând un sentiment de securitate și de calitate la un preț accesibil.

Cu noi mașini și îmbunătățirea modelelor câștigat încrederea în calitate dovedită, vom adăuga beneficii și avantaje suplimentare și să adapteze produsele lor la mediul de piață.

Confortul și avantajul clientilor se afla în topul priorităților brandului. Ne bazăm pe realizarea celui mai bun echilibru dintre designul functional, confort și accesibilitate.



Бормашина акум. Li-ion 7.2V 1300mAh 8Nm / Cordless Drill Li-ion 7.2V 1300mAh 8Nm / Bormasina Cu Acumulator Li-ion 7.2V 1300mAh 8Nm



art. №	model	box	ctn
030129	RD-CDL11		10



Бормашина акум. Li-ion 12V 2-ск. 1300mAh / Cordless Drill Li-ion 12V 2-gears 1300mAh / Bormasina Cu Acumulator Li-ion 12V 2-gears 1300mAh



art. №	model	box	ctn
030143	RD-CDL12		10



Бормашина акум. Li-ion 12V 2-ск. 1300mAh / Cordless Drill Li-ion 12V 2-gears 1300mAh / Bormasina Cu Acumulator Li-ion 12V 2-gears 1300mAh



art. №	model	box	ctn
030144	RD-CDL13		10



Бормашина 500W 13mm / Impact Drill 500W 13mm / Bormasina 500W 13mm



art. №	model	box	ctn
010128	RD-ID26		10



Бглошлаѳ 115mm 500W / Angle Grinder 115mm 500W / Polizor Unghiular 115mm 500W

art. №	model	box	ctn
020133	RD-AG31		6



Кърмач 850W 26mm / Rotary Hammer 850W 26mm / Ciocan Rotopercutor 850W 26mm

art. №	model	box	ctn
013107	RD-HD07		3



ACCESSORIES:
 SDS-plus 8x150 mm drill bit
 SDS-plus 10x150 mm drill bit
 SDS-plus 12x150 mm drill bit
 SDS-plus 14x250 mm mm flat chisel
 SDS-plus 14x250 mm pointed chisel



Кърмач 850W 26mm / Rotary Hammer 850W 26mm / Ciocan Rotopercutor 850W 26mm

art. №	model	box	ctn
013130	RD-HD42		3



Циркулар рѳчен \varnothing 185mm 1200W / Circular Saw \varnothing 185mm 1200W / Ferastrau Circular \varnothing 185mm 1200W

art. №	model	box	ctn
052104	RD-CS16		4



gadget TOOLS
 Basic SKILL TOOLS
 topStrong
 TopGarden
 TopGarden premium
 MAKALON
 topchrome
 BAUKRAFT POWER TOOLS
 GREEN TOOLS



Пробоген трион 350W 55mm / Jig Saw 350W 55mm / Ferestrau Pendular 350W 55mm



art. №	model	box	ctn
050109	RD-JS01		10

Ренде електрическо 600W 82x2mm / Electric Planer 600W 82x2mm / Rindea Electrica 600W 82x2mm



art. №	model	box	ctn
055104	RD-EP01		6

Виброшлайф 150W 90x187mm / Sander 150W 90x187mm / Slefuitor cu vibratii 150W 90x187mm



art. №	model	box	ctn
040109	RD-SA01		10

Пистолет за боя 650W Ø1.5mm 800ml компресор / Electric Spray Gun 650W Ø1.5mm 800ml / Pistolj Za Farbanje 650W Ø1.5mm 800ml



art. №	model	box	ctn
074101	RD-SGC02		4



Пистолет за горещ въздух 1600W 2 смен. / Heat Gun 1600W 2 rates / Pistol cu aer cald 1600W 2 rate

art. №	model	box	ctn
074301	RD-HG13		10



Косачка-тример 250W 220mm / Grass Trimmer 250W 220mm / Trimmer pentru iarba 250W 220mm

art. №	model	box	ctn
075536	GT-GT23		15



Корга с макара за тример / Trimmer Line on Spool for Grass Trimer/ Fir rezerva trimer

art. №	for model	box	ctn
110258	GT-GT23, TG-GT24 & BK-GT25		500



Корга с макара и шайба за косачка тример/ Trimmer Line on Spool for Grass Trimer/ Fir rezerva trimer cu disc

art. №	model	box	ctn
110259	GT-GT23, TG-GT24, BK-GT25		250





Косачка 1000W 320mm 35L / Lawn Mower 1000W 320mm 35L / Masina de tuns iarba 1000W 320mm 35L



art. №	model	box	ctn
075319	GT-LM21		1

Нож за косачка 320mm / Blade for Lawn Mower 320mm / Cutit pentru masina de tuns iaba 320mm



art. №	for model	box	ctn
110265	GT-LM21 & BK-LM22		100

Помпа водна потопяема за мръсна вода 400W 1" max 125L/min 5m / Submersible Pump for Sewage Water 400W 1" max 125L/min 5m / Pompa de apa submersibila 400W 1" max 125L/min 5m



art. №	model	box	ctn
070139	RD-WP32		4

gadger
TOOLS

Basic
SKILLICO

topStrong

TopOrden

TopGarden
premium

MAK
LON

topchrome

AVANTAGE
BAUKRAFT
POWER TOOLS

GREEN
TOOLS

Lined writing area with 20 horizontal lines.

Lined writing area with horizontal lines.



gadger
TOOLS
CS1

Basic
SKILLCO

topStrong

Top
Garden

TopGarden
premium

MHKLON

topchrome

BAUKRAFT
POWER TOOLS

GREEN
TOOLS



25 ГОДИНИ
EUROMASTER

Нашите запазени марки:

RAIDER[®]
Power Tools

topmaster
professional

topStrong

STUTTGART
BAUKRAFT
POWER TOOLS

gadget[®]
TOOLS

TopGarden
premium

GREEN
TOOLS

BASIC
SKILLCO

TopGarden

MAKALON

topchrome

ЕВРОМАСТЕР
Импорт Експорт ООД

Р. България, 1231 София,
бул. "Ломско шосе" 246
тел.: 0700 44 155 за цялата страна
e-mail: info@euromasterbg.com
www.euromasterbg.com

EUROMASTER
Import Export Ltd.

Bulgaria, 1231 Sofia,
246 Lomsko Shose Blvd.
tel.: (00 359) 87 530 0101
e-mail: info@euromasterbg.com
www.euromasterbg.com

EUROMASTER
SRL Romania

Str. Drumul Garii Otopeni,
Nr. 6, Otopeni, Ilfov
Tel.: +4 021 3510106
e-mail: info@euromasters.ro
www.euromasters.ro

"Евромастер Импорт Експорт" ООД, информира, че авторските права на този каталог, включващи неговия текст, поместените фотографии, пиктограми, схеми, чертежи и дизайн, принадлежат изключително на "Евромастер Импорт Експорт" ООД и подлежат на правна защита съгласно „Закона за авторското право и сродните му права“ влязъл в сила на 01.08.1993 г. и последните изменения публикувани в „Държавен вестник“ бр. 32 от 28 Април 2009г. Копирането, публикуването, модифицирането с комерсиална цел на каталога, както и на отделни елементи от него без съгласието на "Евромастер Импорт Експорт" ООД изразено в писмена форма, е строго забранено и може да доведе до привличането към гражданска и наказателна отговорност.

www.euromasterbg.com



 **0700 44 155**
(+359) 87 530 0101

 **info@euromasterbg.com**

 **www.euromasterbg.com**

Art. № 549920

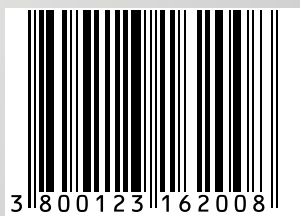

Euromaster Import-Export Ltd
Bulgaria, 1231 Sofia
246, "Lomsko shose" blvd
www.topmaster.bg, www.raider.bg, www.gadget.bg,
www.basic.bg, www.topstrong.bg, www.topgarden.bg,
www.makalon.bg, www.topchrome.bg

